

EDIZIONE

7.2

Magicotex

ITALIAN EXPRESSION

CATALOGO ACCESSORI NAUTICI
MARINE ACCESSORIES

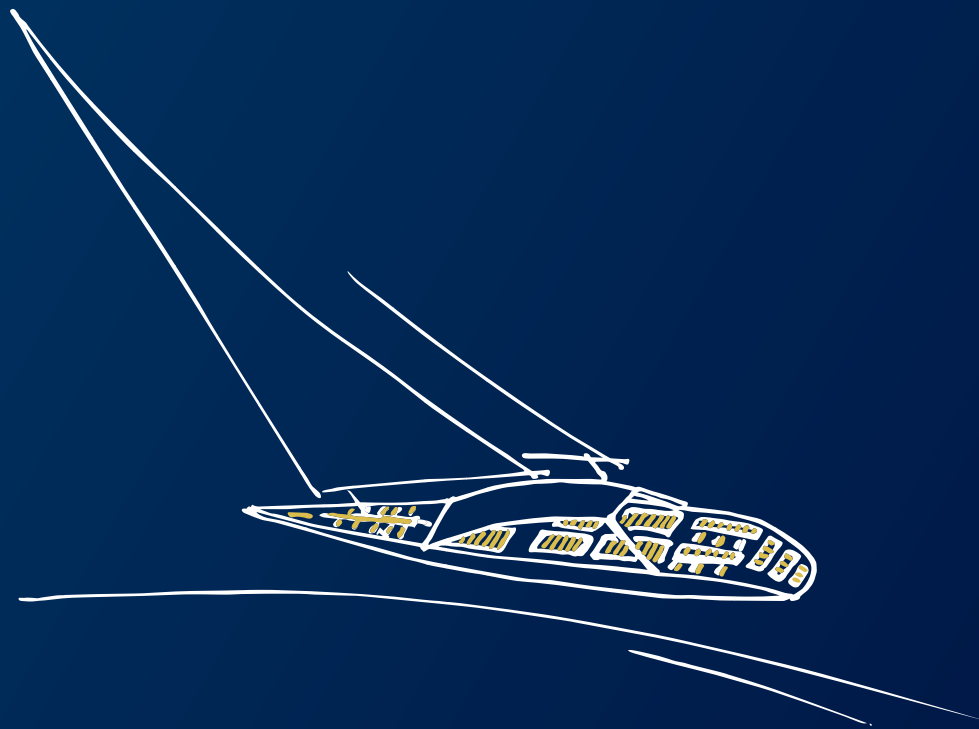

DISTRIBUTOR: **TEMPOTESTMARINE**
ITALIAN PERFORMANCE FABRICS

































Magicotex

ITALIAN EXPRESSION



SOMMARIO

INDEX

	QSNAP	2
	CAF-316	4
	CAF-COMPO	6
	PERFIX	7
	LOXX	11
	STAYPUT	13
	BOTTONI E PUNZONI YKK	17
	DOT	18
	FIOCCHI	22
	MINAX E BOTTONI NY	23
	PINZE	25
	PUNTI E PISTOLE PNEUMATICHE	26
	ANELLE A VELA E PERFORATORI	28
	ACCESSORI PER CAPOTE	30
	PONTICELLI E MOSCHETTONI	35
	RINFORZI	36
	ACCESSORI IN PLASTICA	37
	FUNGHETTI E FERMA TELONI	41
	FIBBIE E FERMACORDA	42
	PROFILI E ACCESSORI	45
	YKK – CERNIERE E CURSORI	47
	COLLA	55
	VELCRO	56
	FISSAGGI PER TAPPEZZERIA	57
	BORDINI	60
	CORDA ELASTICA	64
	FILO	65
	PRODOTTI VARI	66
	FORBICI	67
	GOMMA PER IMBOTTITURE	68
	INSONORIZZANTI	69
	BINARI PER TENDE	70

PRODOTTI Q-SNAP

Q-SNAP



TESTA/Q-CAP (A) con gambo da 4 mm

- 110 000-100 bottone testa in acciaio SS316 - confezione da 100 pezzi
- 110 000-500 bottone testa in acciaio SS316 - confezione da 500 pezzi
- 110 001-100 bottone testa in acciaio SS316 col. Nero - confezione da 100 pezzi
- 110 002-100 bottone testa in acciaio SS316 col. Nero opaco - confezione da 100 pezzi
- 110 003-100 bottone testa in acciaio SS316 col. Bianco perlato - confezione da 100 pezzi
- 110 004-100 bottone testa in acciaio SS316 col. Grigio - confezione da 100 pezzi
- 110 005-100 bottone testa in acciaio SS316 col. Kaki - confezione da 100 pezzi
- 110 006-100 bottone testa in acciaio SS316 col. Navy - confezione da 100 pezzi
- 110 007-100 bottone testa in acciaio SS316 col. Bordeaux - confezione da 100 pezzi

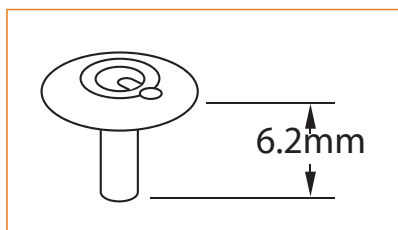

TESTA/Q-CAP (A) con gambo da 6,2 mm

- 110 100-100 bottone testa in acciaio SS316 - confezione da 100 pezzi
- 110 100-500 bottone testa in acciaio SS316 - confezione da 500 pezzi



MOLLA (B) Ø 23 mm

- 120 000-100 molla in acciaio SS3316 - confezione da 100 pezzi
- 120 000-500 molla in acciaio SS3316 - confezione da 500 pezzi

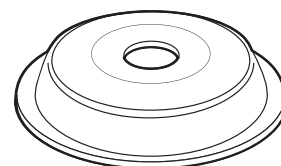

MASCHIO (C)

- 130 000-100 maschio in acciaio SS3316 - confezione da 100 pezzi
- 130 000-500 maschio in acciaio SS3316 - confezione da 500 pezzi
- 130 100-100 maschio con vite autofilettante 4,2x16 in acciaio SS3316 - confezione da 100 pezzi
- 130 100-500 maschio con vite autofilettante 4,2x16 in acciaio SS3316 - confezione da 500 pezzi
- 130 200-100 maschio con vite filettata M4x16 in acciaio SS3316 - confezione da 100 pezzi
- 130 200-500 maschio con vite filettata M4x16 in acciaio SS3316 - confezione da 500 pezzi
- 130 400-100 maschio con vite autoperforante 3,9x16 in acciaio SS3316 - confezione da 100 pezzi
- 130 400-500 maschio con vite autoperforante 3,9x16 in acciaio SS3316 - confezione da 500 pezzi

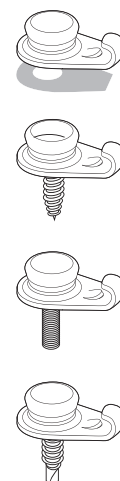

PRODOTTI Q-SNAP

Q-SNAP

	<p>FISSAGGI (D)</p> <p>140 100-100 vite autofilettante 4,2x16 - confezione da 100 pezzi</p> <p>140 100-500 vite autofilettante 4,2x16 - confezione da 500 pezzi</p> <p>140 200-100 vite filettata M4x16 - confezione da 100 pezzi</p> <p>140 200-500 vite filettata M4x16 - confezione da 500 pezzi</p> <p>141 300-100 rivetto 4x10 - confezione da 100 pezzi</p> <p>141 300-500 rivetto 4x10 - confezione da 500 pezzi</p> <p>140 500-100 olgo - confezione da 100 pezzi</p> <p>140 500-1000 olgo - confezioni da 1000 pezzi</p>
--	--

	<p>UTENSILI PER APPLICARE I BOTTONI Q-SNAP</p> <p>190 501-1 pinza manuale per bottoni [vedi pag. 26]</p> <p>190 502-1 confezione da 4 punzoni (A&B, C&D)</p> <p>190 503-1 confezione da 2 punzoni (A&B)</p> <p>190 600-1 punzone manuale (A&B, C&D)</p> <p>190 601-1 punzone manuale (A&B)</p>	
--	---	--

	<p>UTENSILI PER MONTAGGIO VELOCE</p> <p>190 200-1 utensile per montaggio parte C sullo scafo</p> <p>190 300-1 utensile per montaggio parte C sullo scafo (con parte A su tela)</p> <p>190 400-10 utensile per montaggio parte A sulla tela (con parte C su scafo)</p> <p>190 400-25 utensile per montaggio parte A sulla tela (con parte C su scafo)</p>	
--	---	--

Per maggiori informazioni, è possibile guardare il video relativo all'installazione nel sito: www.q-snap.com

PRODOTTI CAF-316



CAF-316

CAF® 316

made to last

by **SURE FAS**

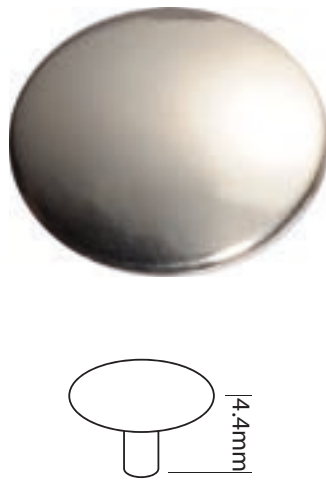
PER LA CHIUSURA DI QUESTI BOTTONI, VEDI PAG. 29

	 <p>TESTA - 316 CAP (A) Ø 15 mm - gambo di 4,4 mm</p> <p>621 0000-100 bottone testa in acciaio SS316 - confezione da 100 pezzi 621 0000-1000 bottone testa in acciaio SS316 - confezione da 1000 pezzi 621 0001-100 bottone testa in acciaio SS316 col. Nero - confezione da 100 pezzi 621 0002-100 bottone testa in acciaio SS316 col. Nero opaco - confezione da 100 pezzi 621 0003-100 bottone testa in acciaio SS316 col. Bianco perlato - confezione da 100 pezzi 621 0004-100 bottone testa in acciaio SS316 col. Grigio - confezione da 100 pezzi 621 0005-100 bottone testa in acciaio SS316 col. Kaki - confezione da 100 pezzi 621 0006-100 bottone testa in acciaio SS316 col. Navy- confezione da 100 pezzi 621 0007-100 bottone testa in acciaio SS316 col. Bordeaux - confezione da 100 pezzi 621 0110-100 bottone testa in acciaio SS316 col. Nero oxide - confezione da 100 pezzi</p>
---	---

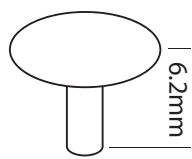
	<p>TESTA - 316 CAP (A) Ø 15 mm- gambo di 6,2 mm</p> <p>621 0100-100 bottone testa in acciaio SS316 - confezione da 100 pezzi 621 0100-1000 bottone testa in acciaio SS316 - confezione da 1000 pezzi</p>
---	--

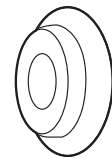
	<p>MOLLA (B)</p> <p>622 0000-100 molla in acciaio SS3316 - confezione da 100 pezzi 622 0000-1000 molla in acciaio SS3316 - confezione da 1000 pezzi 622 0010-100 molla in acciaio SS3316 col. Nero oxide - confezione da 100 pezzi 622 0010-1000 molla in acciaio SS3316 col. Nero oxide - confezione da 1000 pezzi</p>	
---	---	---

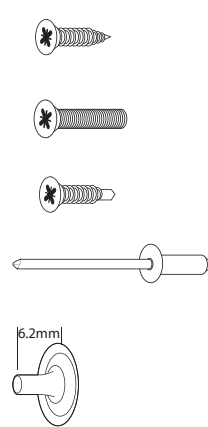
	<p>FISSAGGI (D)</p> <p>140 100-100 vite autofilettante 4,2x16 - confezione da 100 pezzi 140 100-500 vite autofilettante 4,2x16 - confezione da 500 pezzi 140 200-100 vite filettata M4x16 - confezione da 100 pezzi 140 200-500 vite filettata M4x16 - confezione da 500 pezzi 141 300-100 rivetto 4x10 - confezione da 100 pezzi 141 300-500 rivetto 4x10 - confezione da 500 pezzi 140 500-100 olgo - confezione da 100 pezzi 140 500-500 olgo - confezioni da 500 pezzi 240 510-100 olgo col. Nero oxide - confezione da 100 pezzi 240 510-1000 olgo col. Nero oxide - confezione da 1000 pezzi</p>	
---	--	---

PRODOTTI CAF-316

CAF-316

	<p>MASCHIO (C)</p> <p>623 0000-100 maschio in acciaio SS316 - confezione da 100 pezzi</p> <p>623 0000-1000 maschio in acciaio SS316 - confezione da 1000 pezzi</p> <p>623 0010-100 maschio in acciaio SS316 col. Nero oxide - confezione da 100 pezzi</p> <p>623 0010-1000 maschio in acciaio SS316 col. Nero oxide - confezione da 1000 pezzi</p> <p>623 0110-100 maschio con vite filettata 10 mm in acciaio SS316 - confezione da 100 pezzi</p> <p>623 0110-1000 maschio con vite filettata 10 mm in acciaio SS316 - confezione da 1000 pezzi</p> <p>623 0116-100 maschio con vite filettata 16 mm in acciaio SS316 - confezione da 100 pezzi</p> <p>623 0116-1000 maschio con vite filettata 16 mm in acciaio SS316 - confezione da 1000 pezzi</p> <p>623 0316-100 maschio con vite "grande" filettata 16 mm in acciaio SS316 - confezione da 100 pezzi</p> <p>623 0316-1000 maschio con vite "grande" filettata 16 mm in acciaio SS316 - confezione da 1000 pezzi</p> <p>623 0416-100 maschio con vite autofilettante 16 mm in acciaio SS316 - confezione da 100 pezzi</p> <p>623 0416-1000 maschio con vite autofilettante 16 mm in acciaio SS316 - confezione da 1000 pezzi</p> <p>623 0206-100 maschio per doppio telo da abbinare a parte B - confezione da 100 pezzi</p> <p>623 0206-1000 maschio per doppio telo da abbinare a parte B - confezione da 1000 pezzi</p>	
		

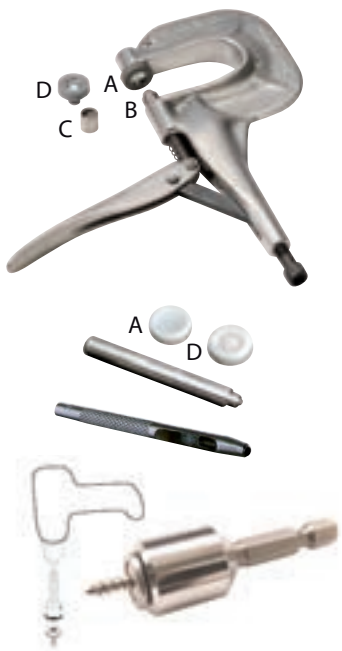
	<p>UTENSILI PER APPLICARE I BOTTONI Q-SNAP</p> <p>190 501-1 pinza manuale per bottoni [vedi pag. 26]</p> <p>190 502-1 confezione da 4 punzoni (A&B, C&D)</p> <p>190 503-1 confezione da 2 punzoni (A&B)</p> <p>190 504-1 confezione da 2 punzoni (C&D)</p> <p>190 600-1 punzone manuale (A&B, C&D)</p> <p>190 601-1 punzone manuale (A&B)</p> <p>190 700-1 punzone manuale 4 mm</p> <p>290100-1 adattatore per trapano per fissaggio parte (C)</p>
---	---

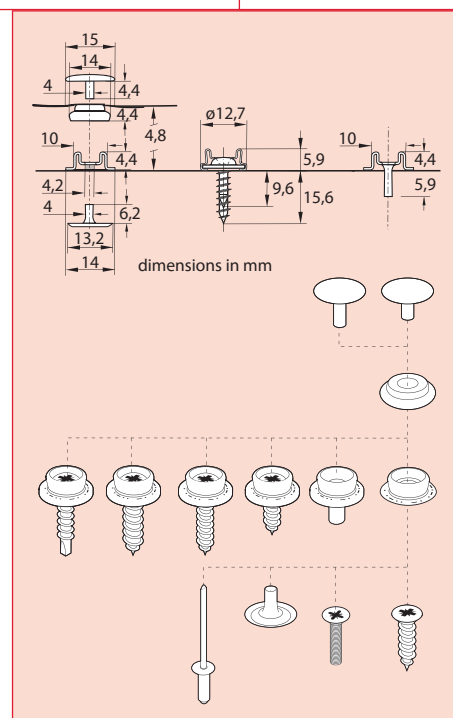

Per maggiori informazioni, è possibile guardare il video relativo all'installazione nel sito: www.q-snap.com

PRODOTTI CAF-COMPO

CAF-COMPO

CAF[®] COMPO

made to match

by **SURE FAS**



Vite autofilettante per l'uso in fibra di vetro, legno e altri materiali compositi.

- 635116-10 CAF-COMPO** colore bianco - conf. da 10 pezzi
- 6351116-100 CAF-COMPO** colore bianco - conf. da 100 pezzi
- 6352116-10 CAF-COMPO** colore crema - conf. da 10 pezzi
- 6352116-100 CAF-COMPO** colore crema - conf. da 100 pezzi
- 6353116-10 CAF-COMPO** colore grigio - conf. da 10 pezzi
- 6353116-100 CAF-COMPO** colore grigio - conf. da 100 pezzi
- 6354116-10 CAF-COMPO** colore nero - conf. da 10 pezzi
- 6354116-100 CAF-COMPO** colore nero - conf. da 100 pezzi



Per maggiori informazioni, è possibile guardare il video relativo all'installazione nel sito: www.q-snap.com

TESTA CAP

PERFIX®

safe and secure

by **SURE FAS**

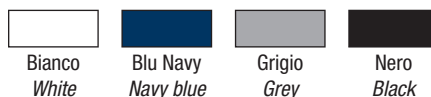

301-000 Colore Bianco / *White Color*
301-001 Colore Blu Navy / *Blue Navy Color*
301-002 Colore Nero / *Black Color*
301-003 Colore Grigio / *Grey Color*
 (Confezioni da 100 pz + **1 chiave 301-200 in omaggio**
Pack of 100 pieces + 1 key 301-200 free of charge)

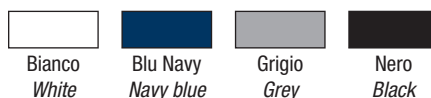

301-010 Colore Bianco / *White Color*
301-011 Colore Blu Navy / *Blue Navy Color*
301-012 Colore Nero / *Black Color*
301-013 Colore Grigio / *Grey Color*
 (Blister da 10 pezzi / *Blister 10 pieces*)

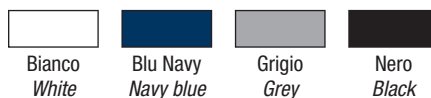

301-020 Colore Bianco / *White Color*
301-021 Colore Blu Navy / *Blue Navy Color*
301-022 Colore Nero / *Black Color*
301-023 Colore Grigio / *Grey Color*
 (Confezione con 4 bottoni + **1 chiave 301-200 + 1 punzone 301-303**
Blister 4 pieces + 1 key 301-200 + punch 301-303)



MASCHIO RECEVEIR

PERFIX®

safe and secure

by **SURE FAS**



- 301-100** Colore Bianco / *White Color*
 - 301-101** Colore Blu Navy / *Blue Navy Color*
 - 301-102** Colore Nero / *Black Color*
 - 301-103** Colore Grigio / *Grey Color*
 - 301-104** Colore Avorio / *Ivory Color*
- (Confezioni da 100 pezzi compreso vite inox / *Pack of 100 pieces with screw*)



- 301-110** Colore Bianco / *White Color*
 - 301-111** Colore Blu Navy / *Blue Navy Color*
 - 301-112** Colore Nero / *Black Color*
 - 301-113** Colore Grigio / *Grey Color*
 - 301-114** Colore Avorio / *Ivory Color*
- (Blister da 10 pezzi con vite inox / *Blister 10 pieces with screw*)



- 301-120** Colore Bianco / *White Color*
 - 301-121** Colore Blu Navy / *Blue Navy Color*
 - 301-122** Colore Nero / *Black Color*
 - 301-123** Colore Grigio / *Grey Color*
 - 301-124** Colore Avorio / *Ivory Color*
- (Blister da 4 pezzi con vite inox / *Blister 4 pieces with screw*)

MASCHIO TELO-TELO

RECEIVEIR CLOTH-CLOTH

PERFIX®

safe and secure

by **SURE FAS**

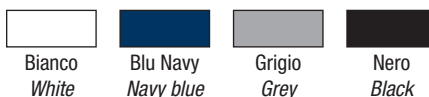

301-150 Colore Bianco / *White Color*
301-151 Colore Blu Navy / *Blue Navy Color*
301-152 Colore Nero / *Black Color*
301-153 Colore Grigio / *Grey Color*
 (Confezioni da 100 pezzi / *Pack of 100 pieces*)

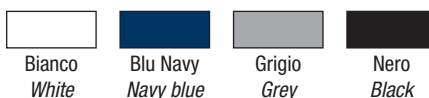

301-160 Colore Bianco / *White Color*
301-161 Colore Blu Navy / *Blue Navy Color*
301-162 Colore Nero / *Black Color*
301-163 Colore Grigio / *Grey Color*
 (Blister da 10 pezzi / *Blister of 10 pieces*)

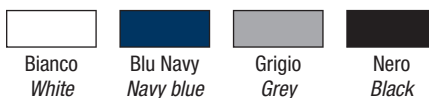

301-170 Colore Bianco / *White Color*
301-171 Colore Blu Navy / *Blue Navy Color*
301-172 Colore Nero / *Black Color*
301-173 Colore Grigio / *Grey Color*
 (Blister da 4 pezzi / *Blister of 4 pieces*)



CONFEZIONI SPECIALI

SPECIAL PACKAGES

PERFIX®

safe and secure

by **SURE FAS**



9901 STARTER KIT

30 bottoni testa col. bianco+
30maschi col. bianco+10 telo/telo
col. bianco+30 viti+30 M4+30
viti autofilettanti+5rivetti+chiave
per montaggio+perforatore+10
utensili per posa bottone.
30 botton white+30 receiver S
white+10 Receiver C-C white+30
Screw+30 M4+30 Self-drill-
screw+5Blind-rivet+tool+hole-
punch+10 installation-pins



301-180 DIY-PACK

5 bottoni testa col. Bianco+5
maschi col. Bianco+ viti+chiave
per montaggio+perforatore
5 botton white+5 receiver
s+screw+incl. key+hole punch

PUNZONI / HOLE PUNCH



301-303

Punzone per foro testa Perfix.
Hole punch for Perfix button



420-100

Punzone colpo per testa perfix Ø
13 mm.
Professional hole punch Ø 13 mm.

PINZE MANUALI / PRES'nSNAP PLIERS



190-501-1

Pinza manuale per bottoni.
Pres'nSnap pliers.



301-200

Chiave Perfix.
Key for Perfix.



301-201

Chiave con manico in legno Perfix.
Tool key Perfix.

STRUMENTI PER RISPARMIARE TEMPO / TIME SAVING TOOLS



301-301

Utensile per posizionare il bottone
testa Perfix su telo.
Installation pix Perfix.



301-302

Utensile per posa Perfix maschio.
Drill-stencil Perfix.



PRODOTTI LOXX®

LOXX® PRODUCTS

LOXX®

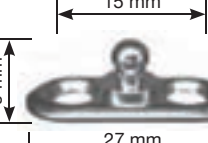
	<p>300-000 LOXX testa piccola in ottone cromato <i>LOXX upper part small head, brass chrome plated</i></p>		<p>300-002 LOXX testa grande in ottone cromato <i>LOXX upper part big head, brass chrome plated</i></p>
	<p>300-030 LOXX maschio telo contro telo in ottone cromato <i>LOXX lower part for fabric, brass chrome plated</i></p>		<p>300-033 LOXX maschio su piastra a due fori in ottone cromato <i>LOXX ovale plate standard, brass chrome plated</i></p>
	<p>300-032 LOXX vite autofilettante in INOX, 4,2 mm x 12 mm <i>Self tapping screw stainless steel, 4,2 mm x 12 mm</i></p>		<p>300-033L LOXX maschio su piastra a due fori in ottone cromato <i>LOXX ovale plate standard, brass chrome plated</i></p>
	<p>LOXX vite autofilettante in ottone cromato <i>Self tapping screw brass chrome plated</i> 300-036 Vite lunga 10 mm / <i>Screw lenght 10 mm</i> 300-031 Vite lunga 16 mm / <i>Screw lenght 16 mm</i> 300-038 Vite lunga 22 mm / <i>Screw lenght 22 mm</i></p>		
	<p>300-046 LOXX maschio su base circolare Ø24 mm H9 mm <i>Glueable round plate Ø24 mm H9 mm</i></p>		<p>300-047 LOXX maschio su base circolare con fori Ø24 mm H9 mm <i>Screwable round plate Ø24 mm H9 mm</i></p>
	<p>300-041 LOXX clip per parabrezza 21 mm / <i>Windshield clip 21 mm</i> 300-040 LOXX clip per parabrezza 24 mm / <i>Windshield clip 24 mm</i></p>		
	<p>300-045 LOXX maschio per telo a rivetto - 2 pezzi <i>Selfpiercing - 2 pieces</i></p>		<p>300-050 LOXX tappo a espansione per canaline <i>Expansion cap</i></p>

PRODOTTI LOXX®

LOXX® PRODUCTS



	<p>300-034 LOXX maschio con gambo filettato in ottone cromato lunghezza vite 10 mm <i>Metric screw brass chrome plated screw lenght 10 mm</i></p>
---	--

	<p>300-037 LOXX maschio con gambo filettato in INOX lunghezza vite 25 mm <i>Metric screw in INOX screw lenght 25 mm</i></p>
---	--

	<p>Fascetta LOXX per tubo <i>Pipe clamps</i> 300-042 Ø 22 mm 300-043 Ø 25 mm 300-044 Ø 30 mm</p>
---	---

	<p>300-200 Chiave per bloccaggio testa LOXX in legno e acciaio <i>Big key with wooden handle</i></p>
---	---

	<p>300-203 Utensile per aprire e chiudere il bottone testa LOXX <i>Pull and close key</i></p>
--	--

	<p>300-202 Altezza / <i>Height</i>: 5 cm Diametro / <i>Diameter</i>: 2.2 cm Diametro interno / <i>Internal diameter</i>: 1 cm Utensile per avvitatore elettrico e pneumatico, utilizzabile per montaggio e smontaggio <i>LOXX tool for electric screw driver for standard washer</i></p>
---	--



PRODOTTI STAYPUT

STAYPUT PRODUCTS

	<p>TESTA/CAP 323-000 Bianco / <i>White</i> 323-001 Nero / <i>Black</i> 323-002* Bordeaux / <i>Bordeaux</i> 323-003* Grigio / <i>Grey</i> 323-004* Blu royal / <i>Royal blue</i> 323-005 Blu navy / <i>Navy blue</i> 323-006 Beige / <i>Beige</i></p>	
	<p>MOLLA/STUD 323-020 Bianco / <i>White</i> 323-021 Nero / <i>Black</i></p>	
	<p>MASCHIO/BASE 323-030 Bianco / <i>White</i> 323-031 Nero / <i>Black</i></p>	

	<p>323-040 Maschio per tubo, bianco <i>Tube for tube, white color</i></p>
--	--

	<p>323-041 Maschio per tubo, nero <i>Tube for tube, black color</i></p>
--	--

PRODOTTI STAYPUT

STAYPUT PRODUCTS



	<p>323-120 Gancio per tendoni bianco Marquee hook, white color</p>		<p>323-121 Gancio per tendoni nero Marquee hook, black color</p>	
--	---	--	---	--



	<p>323-090 Clip con elastico bianco Schock cord loop, white color</p>		<p>323-091 Clip con elastico nero Schock cord loop, black color</p>
--	--	--	--

<p>323-111 Piastra circolare orizzontale bianco Horizontal dome hook, white color</p> <p>323-112 Piastra circolare orizzontale marrone Horizontal dome hook, Brown color</p>	<p>323-110 Piastra circolare verticale bianco Verticale dome hook, white color</p>	



PRODOTTI STAYPUT

STAYPUT PRODUCTS



323-100
Funghetto in plastica bianco
Shock cord know, white color



323-101
Funghetto in plastica nero
Shock cord know, black color

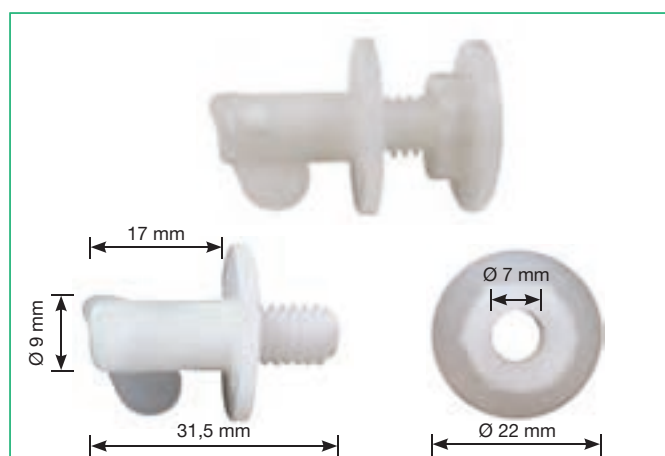

323-055 Fissaggio telo-telo doppio tessuto bianco
Canvas to canvas double, white color
323-053 Fissaggio telo-telo doppio tessuto nero
Canvas to canvas double, black color



323-050 Fissaggio telo-telo bianco
Canvas to canvas single, white color
323-051 Fissaggio telo-telo nero
Canvas to canvas single, black color

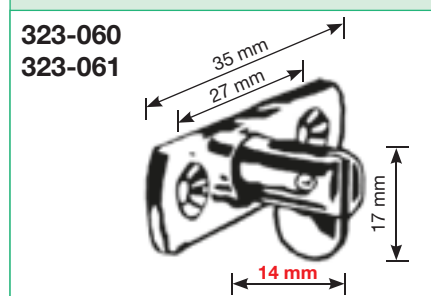
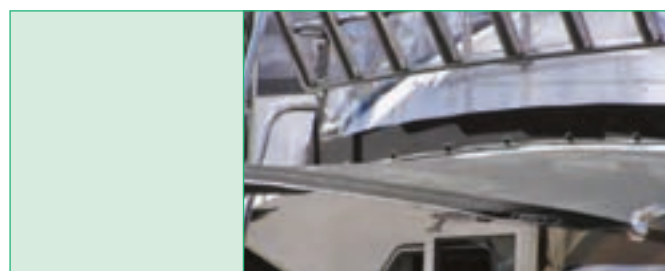

323-060 Fissaggio orizzontale bianco
Horizontal fixing, white color
323-061 Fissaggio orizzontale nero
Horizontal fixing, black color

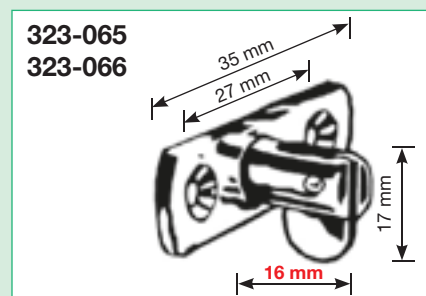

323-065 Fissaggio orizzontale doppio telo bianco
Horizontal fixing double fabric, white color
323-066 Fissaggio orizzontale doppio telo nero
Horizontal fixing double fabric, black color

PRODOTTI STAYPUT

STAYPUT PRODUCTS



323-070

323-071

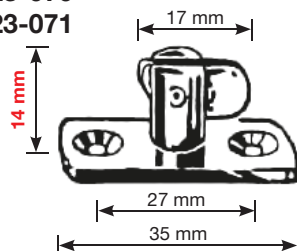

323-070 Fissaggio verticale bianco
Vertical fixing, white color

323-071 Fissaggio verticale nero
Vertical fixing, black color



323-075

323-076

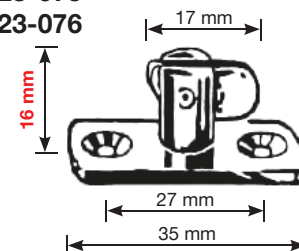

323-075 Fissaggio verticale doppio telo bianco
Vertical fixing double fabric, white color

323-076 Fissaggio verticale doppio telo nero
Vertical fixing double fabric, black color



323-080

Adattatore per tubo per fissaggi verticali e orizzontali bianco
Horizontal and vertical curved base accessory, white color

323-081

Adattatore per tubo per fissaggi verticali e orizzontali nero
Horizontal and vertical curved base accessory, black color



323-140

Gancio scorrevole per art.
26600+26700+26000+26102/b, colore bianco
Rope track slide for art.
26600+26700+26000+26102/b, white color

323-141

Gancio scorrevole per art.
26600+26700+26000+26102/b, colore nero
Rope track slide for art.
26600+26700+26000+26102/b, black color



323-045

Pinza manuale per chiusura bottone in plastica
Hand tool for cap and stud for easy installation

Bottoni YKK • YKK Buttons

BOTTONI YKK

YKK BUTTONS



PER LA CHIUSURA DI QUESTI BOTTONI, VEDI PAG. 25



324-000

YKK bottone testa Ø 15.5mm in acciaio AISI 316
YKK cap Ø 15.5mm stainless steel AISI 316



324-100

YKK molla in acciaio AISI 316 per testa 324-000
YKK socket stainless steel AISI 316 for 324-000



324-200

YKK maschio in acciaio AISI 316
YKK stud stainless steel AISI 316



324-300

YKK olgo in acciaio AISI 316
YKK fixing stainless steel AISI 316



324-400

Punzone per bottone testa YKK, lavora in abbinamento con art. 324-500 / *Attaching die for Ykk cap button, works in combination with art. 324-500*



324-500

Punzone per molla YKK, lavora in abbinamento con art. 324-400 / *Attaching die for YKK socket, works in combination with art. 324-400*



324-600

Punzone per maschio YKK, lavora in abbinamento con art. 324-700 / *Attaching die for YKK stud, works in combination with art. 324-700*



324-700

Punzone per olgo YKK, lavora in abbinamento con art. 324-600 / *Attaching die for post, works in combination with art. 324-600*

PRODOTTI DOT

DOT PRODUCTS



302-000

Testa DOT ottone nickel, 2 pezzi
Socket in brass nickel, 2 pieces

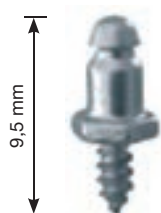
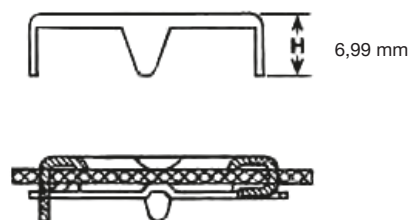

302-030

Maschio DOT h 9,5 mm, ottone nickel
Screw stud h 9,5 mm in brass nickel

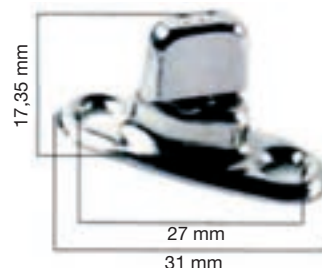

303-301

Tornichetto DOT in ottone nickel h 17,35 mm
Turn button in brass nickel h 17,35 mm



302-031

Maschio DOT h 25 mm, ottone nickel
Screw stud h 25 mm in brass nickel

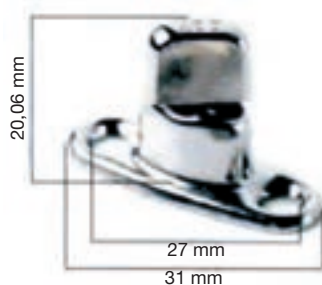

303-300

Tornichetto DOT in ottone nickel h 20,06 mm
Turn button in brass nickel h 20,06 mm

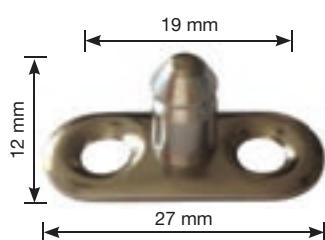

302-032

Base maschio DOT
DOT post

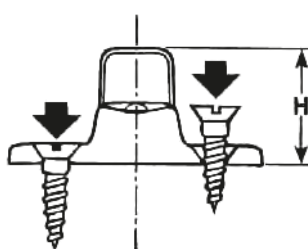

PRODOTTI DOT

DOT PRODUCTS



302-200
 Punzone a colpo for
 DOT 302-000
*Hand punch for DOT
 302-000*



303-400
 Punzone per DOT asola 303-350
Punch for washers DOT 303-350



303-350
 Asola per tornichetto DOT 303-300 e 303-301 (2 pezzi)
Washer for turn botton 303-300 and 303-301 (2 pieces)

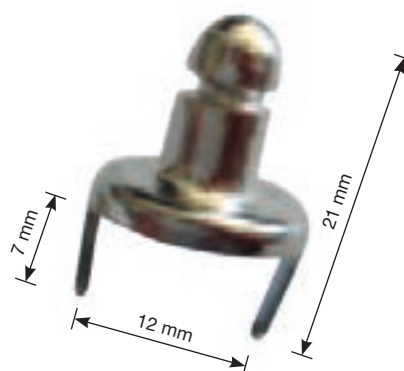
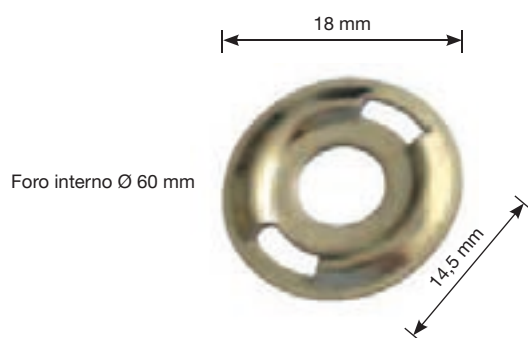

302-033
 Perno per tela e sotto perno (2 pezzi)
Pin for canvas and underpin (2 pieces)

PRODOTTI DOT

DOT PRODUCTS



PER LA CHIUSURA DI QUESTI BOTTONI, VEDI PAG. 25



Parte A / A part

322-000 Testa DOT con gambo corto D 15,24 mm H 4,32 mm
Cap with short stem D 15,24 mm H 4,32 mm

322-001 Testa DOT con gambo lungo D 15,24 mm H 6,10 mm / *Cap with long stem D 15,24 mm H 6,10 mm*

322-002 Testa DOT con gambo lungo D 15,24 mm H 6,10 mm in INOX 316 / *Cap with long stem D 15,24 mm H 6,10 mm in INOX 316*

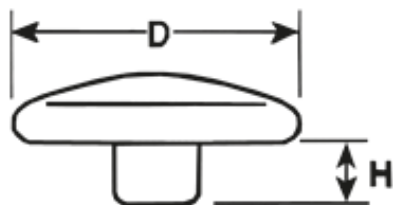

Ø 14 mm



Parte B / B part

322-100 Molla DOT
Socket

322-102 Molla DOT in INOX 316
Socket in INOX 316

Ø 14 mm



Parte D / D part

322-300
Olgo DOT
Posts

Ø 14 mm



Parte C / C part

322-200
Maschio DOT
Stud

322-201
Maschio DOT interno profondo per

testa vite in ottone nickel
Stud deep for screw brass nickel plated

322-202
Maschio DOT in INOX 316
Stud in inox 316



Parte C / C part

322-210
Maschio DOT autoperforante in ottone nickel, vite lunga 10 mm
Stud self-drilling brass plated nickel- 10 mm lenght

322-211
Maschio DOT autoperforante in ottone nickel, vite lunga 16 mm
Stud self-drilling brass plated nickel- 16 mm lenght



Parte C / C part

322-220
Maschio DOT autofilettante in ottone nickel, vite lunga 10 mm
Stud self-tapping brass plated nickel - 10 mm

322-221
Maschio DOT autofilettante in ottone nickel, vite lunga 16 mm
Stud self-tapping brass plated nickel - 10 mm

PRODOTTI DOT

DOT PRODUCTS



322-M840

Pinza DOT manuale per i vari punzoni
DOT Snapmaster®



Parte A / A part

322-000P840

Punzone Dot per art. 322-000, 322-001, 322-002 per la pinza 322-M840
Tool for art. 322-000, 322-001, 322-002 for DOT Snapmaster®



Parte B / B part

322-200P840

Punzone DOT per art. 322-200, 322, 201, 322-202 per pinza 322-M840
Tool for art. 322-200, 322, 201, 322-202 for DOT Snapmaster®



Parte C / C part

322-100P840

Punzone DOT per molla 322-100 e 322-102 per pinza 322-M840
Tool for art. 322-100 e 322-102 for DOT Snapmaster®



Parte D / D part

322-300P840

Punzone DOT per olgo 322-300 per pinza 322-M840
Tool for art. 322-300 for DOT Snapmaster®



322-000P840G

Ricambio in gomma per DOT art. 322-300P840
Rubber spare for DOT 322-300P840



322-000PC

Perforatore a colpo per art. 322-000, 322-001, 322-002
Hand tool for art. 322-000, 322-001, 322-002



301-299

Attrezzo universale per togliere i bottoni facilmente
Universal tool for easy button removal



322-210CM

Chiave manuale DOT per avvitare i art. 322-210, 322-211, 322-220, 322-221
Manual key to screw art. 322-000, 322-001, 322-002

PRODOTTI FIOCCHI

FIOCCHI PRODUCTS

FIOCCHI



303-335
Asola in ottone nickel per 303-330 e 303-331 - 2 pezzi
Brass nickel plated grommet for 303-330 and 303-331 - 2 pieces





303-336
Punzone per art. 303-335
Punch for art. 303-335

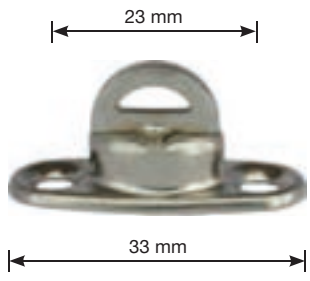

303-330
Tornichetto in ottone nickel, gambo corto H 15 mm
Turnbutton in brass nickel plated short stem H 15 mm

303-331
Tornichetto in ottone nickel, gambo lungo H 18 mm
Turnbutton brass nickel plated long stem H 18 mm





303-337
Perforatore a martello per asola 303-335
Hole punch for 303-335



320-100
Molla in ottone nickel
Socket brass nickel plated

321-110
Molla in acciaio
Socket stainless steel

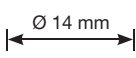

Parte B / B part

320-200
Maschio in ottone nickel
Stud brass nickel plated

321-210
Maschio in acciaio
Stud stainless steel

Parte C / C part

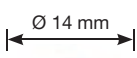
320-300
Olgo in ottone nickel
Rivet brass nickel plated

321-310
Olgo in acciaio
Rivet stainless steel

Parte D / D part

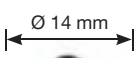

PER LA CHIUSURA DI QUESTI BOTTONI, VEDI PAG. 29



Parte A / A part

320-000
Testa in ottone nickel Ø17 mm
Cap brass nickel plated Ø17 mm

321-010
Testa in acciaio Ø17 mm
Cap stainless steel Ø17 mm

*Su richiesta è possibile creare un personalizzazione
On request it is possible to create a personalization



Parte A / A part

321-001
Testa in acciaio Ø15 mm
Cap stainless steel Ø15 mm



420-110
Punzone a martello foro Ø 3 mm
Punch for hole Ø 3 mm

Prodotti MINAX • MINAX Products

PRODOTTI MINAX

MINAX PRODUCTS

MINAX®

MINAX®

304-000
 Parte superiore in nylon bianco
Upper part in white nylon

MINAX®

304-002
 Parte inferiore in nylon bianco
Lower part in white nylon

MINAX®

304-001
 Vite autofilettante
Self-tapping screw

Bottoni automatici personalizzati • Custom Snaps

BOTTONI AUTOMATICI PERSONALIZZATI

CUSTOM SNAPS

321-050
 Bottone testa in nylon resistente ai raggi UV, colori vari (personalizzazione, su richiesta)
Cap button in nylon resistant to UV rays, various colors (personalization, on request)

PUNZONI PER BOTTONI

PUNCHES FOR BUTTONS



Parte A / A part

330-000

Punzone per testa Ø 17 mm, lavora in abbinamento con 330-003, anche per DOT

Punch for cap Ø 17 mm, works in combination with 330-003, also for DOT



Parte B / B part

330-003

Punzone per molla, lavora in abbinamento con 330-000,010,100, anche per DOT

Socket punch, works in combination with 330-000,010,100, also for DOT



Parte A / A part

330-100

Punzone per testa Ø 15,5 mm, lavora in abbinamento con 330-003, anche per DOT

Punch for cap Ø 15,5 mm, works in combination with 330-003, also for DOT



Parte C / C part

330-001

Punzone per maschio, lavora in abbinamento con 330-005, anche per DOT

Stud punch, works in combination with 330-005, also for DOT



Parte A / A part

330-010

Punzone testa nylon, lavora in abbinamento con 330-003, anche per DOT

Punch for nylon cap, works in combination with 330-003, also for DOT



Parte D / D part

330-005

Punzone per olgo, lavoro in abbinamento con 330-001, anche per DOT

Post punch, works in combination with 330-001, also for DOT

Pinze • Pliers

PINZE

PLIERS



QUESTO
PRODOTTO UTILIZZA
I PUNZONI DI PAG. 28
*THIS PRODUCT USES
THE PUNCHES ON
PAG. 28*

340-001

Pinza manuale per anelle a vela e bottoni Fiocchi, Dot, Caf, Ykk.

Hand tool for sail rings and bottons Fiocchi, Dot, Caf, Ykk.

340-016

Ricambio per pinza 340-001 (molla+perno)

Replacement for clamp 340-001 (spring+pin)



PER I PUNZONI
VEDI PAG. 3 (Q-snap)
e PAG. 5 (CAF)

FOR PUNCHES SEE
PAG. 3 (Q-snap) and
PAG. 5 (CAF)

190 501-1

Pinza manuale per bottoni Q snap e CAF

Hand tool for Q snap and CAF



QUESTO
PRODOTTO UTILIZZA
I PUNZONI DI PAG. 28
*THIS PRODUCT USES
THE PUNCHES ON
PAG. 28*

340-000

Pinza manuale per bottoni Fiocchi, Dot, Caf, Ykk.

NON GARANTITA

Hand tool for bottons Fiocchi, Dot, Caf, Ykk.

NOT GUARANTEED



QUESTO
PRODOTTO UTILIZZA
I PUNZONI DI PAG. 28
*THIS PRODUCT USES
THE PUNCHES ON
PAG. 28*

340-100

Torchietto da banco a leva verticale. Professionale e di grande resistenza, permette di chiudere anelle a vela e bottoni (Fiocchi, Dot, Caf, Ykk).

Press with vertical lever.

Professional and with great resistance, allows you to easily close sail ring and bottons (Fiocchi, Dot, Caf, Ykk).

PUNTI E PISTOLE PNEUMATICHE

STAPLES AND PNEUMATICS PITCHS



340-011

Pinza revolver forgiata con 6 fustelle intercambiabili da mm 2-2,5-3-3,5-4-5

Massive revolving punch pliers with 6 changeable punches mm 2-2,5-3-3,5-4-5



347-001

Pinza per punti e capi corda staples and rope terminals pliers



340-015

Serie base fustelle per pinza 340-010 - 6 pezzi Ø 2-2,5-3-3,5-4-4,5

Based Series punches for 340-010 clamp - 6 pieces Ø 2-2,5-3-3,5-4-4,5



345-000

Punti P7 per tappezzeria NON per uso nautico - conf. da 2500 pezzi
Upholstery staples P7 NOT for nautical use - box 2500 pieces

345-001

Punti P7 per tappezzeria NON per uso nautico - conf. da 3000 pezzi
Upholstery staples P7 NOT for nautical use - box 3000 pieces



Capo corda INOX confezioni da 100 pezzi

Rope terminals in INOX box 100 pcs

346-001 per corda da mm 4 for 4 mm rope

346-002 per corda da mm 6 for 6 mm rope

346-003 per corda da mm 8 for 8 mm rope

346-004* per corda da mm 10 for 10 mm rope

Punti e pistole pneumatiche • Staples and pneumatics pitches

PUNTI E PISTOLE PNEUMATICHE

STAPLES AND PNEUMATICS PITCHS



Pistola pneumatica becco corto
Pneumatic gun with short burner
25000 passo da 80 / pitch 80



Pistola pneumatica becco lungo
Pneumatic gun with long burner
25100 passo da 80 / pitch 80



PUNTI METALLICI IN ACCIAIO INOX AISI 316 passo da 80
STAPLES PACK STAINLESS STEEL AISI 316 pitch 80
23001 - 80/06 confezione 10.000 pezzi
23002 - 80/08 confezione 10.000 pezzi
23003 - 80/10 confezione 10.000 pezzi
23004 - 80/12 confezione 10.000 pezzi
23005 - 80/14 confezione 10.000 pezzi



PUNTI METALLICI BRONZATI passo da 80
STAPLES PACK BRONZED pitch 80
23101 - 80/06 confezione 10.000 pezzi
23102 - 80/08 confezione 10.000 pezzi
23103 - 80/10 confezione 10.000 pezzi
23104 - 80/12 confezione 10.000 pezzi
23105 - 80/14 confezione 10.000 pezzi

ANELLE A VELA E PERFORATORI

O-RINGS AND TOOLS



ANELLE A VELA IN OTTONE NICKEL (2 pezzi)

VELA RING NICKEL PLATED BRASS (2 pieces)

- 400-031 Tipo 31-foro Ø 8 mm / hole Ø 8 mm
- 400-040 Tipo 40-foro Ø 10 mm / hole Ø 10 mm
- 400-050 Tipo 50-foro Ø 12 mm / hole Ø 12 mm
- 400-060 Tipo 60-foro Ø 14 mm / hole Ø 14 mm
- 400-070 Tipo 70-foro Ø 16 mm / hole Ø 16 mm
- 400-080 Tipo 80-foro Ø 18 mm / hole Ø 18 mm
- 400-100 Tipo 100-foro Ø 24 mm / hole Ø 24 mm
- 400-150* Tipo 150-foro Ø 40 mm / hole Ø 40 mm

ANELLE A VELA IN ACCIAIO (2 pezzi)

VELA RING STAINLESS STEEL (2 pieces)

- 400-032 Tipo 31-foro Ø 8 mm / hole Ø 8 mm
- 400-041 Tipo 40-foro Ø 10 mm / hole Ø 10 mm
- 400-051 Tipo 50-foro Ø 12 mm / hole Ø 12 mm
- 400-061 Tipo 60-foro Ø 14 mm / hole Ø 14 mm
- 400-071 Tipo 70-foro Ø 16 mm / hole Ø 16 mm
- 400-081 Tipo 80-foro Ø 18 mm / hole Ø 18 mm
- 400-101 Tipo 100-foro Ø 24 mm / hole Ø 24 mm
- 400-151* Tipo 150-foro Ø 40 mm / hole Ø 40 mm

ANELLE A VELA IN ALLUMINIO (2 pezzi)

VELA RING ALUMINIUM (2 pieces)

- 400-033* Tipo 31-foro Ø 8 mm / hole Ø 8 mm
- 400-042* Tipo 40-foro Ø 10 mm / hole Ø 10 mm
- 400-052* Tipo 50-foro Ø 12 mm / hole Ø 12 mm
- 400-062* Tipo 60-foro Ø 14 mm / hole Ø 14 mm
- 400-072* Tipo 70-foro Ø 16 mm / hole Ø 16 mm
- 400-082* Tipo 80-foro Ø 18 mm / hole Ø 18 mm



ANELLE A VELA IN PLASTICA MONTAGGIO RAPIDO

Ø interno 16 mm - Ø esterno 32 mm

PLASTIC VELA RING FAST ASSEMBLY

Ø internal 16 mm - Ø external 32 mm

462-001 blu / blue

462-002 bianco / white

462-003 nero / black

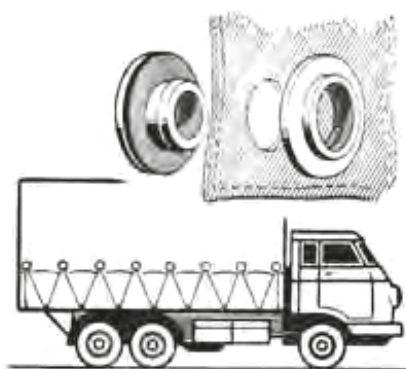

461-000

Anelle a vela per sfiati in nylon Ø 13,5 colore bianco/nero - 2 pezzi

Nylon perforated vela ring Ø 13,5, color white/black - 2 pieces

ANELLE A VELA E PERFORATORI

O-RINGS AND TOOLS



Perforatore manuale per montare le anella a vela
Manual punch for mounting eyelets

- 411-000** Per Tipo 31-foro Ø 8 mm / hole Ø 8 mm
- 411-001** Per Tipo 40-foro Ø 10 mm / hole Ø 10 mm
- 411-002** Per Tipo 50-foro Ø 12 mm / hole Ø 12 mm
- 411-003** Per Tipo 60-foro Ø 14 mm / hole Ø 14 mm
- 411-004** Per Tipo 70-foro Ø 16 mm / hole Ø 16 mm
- 411-005*** Per Tipo 80-foro Ø 18 mm / hole Ø 18 mm
- 411-006*** Tipo 100-foro Ø 24 mm / hole Ø 24 mm
- 411-007*** Tipo 150-foro Ø 40 mm / hole Ø 40 mm



Punzone per anelle a vela (2pezzi)
Eyelets Punch (2 pieces)

- 410-000** Per Tipo 31-foro Ø 8 mm / hole Ø 8 mm
- 410-001** Per Tipo 40-foro Ø 10 mm / hole Ø 10 mm
- 410-002** Per Tipo 50-foro Ø 12 mm / hole Ø 12 mm
- 410-003** Per Tipo 60-foro Ø 14 mm / hole Ø 14 mm
- 410-004** Per Tipo 70-foro Ø 16 mm / hole Ø 16 mm
- 410-005*** Per Tipo 80-foro Ø 18 mm / hole Ø 18 mm
- 410-006*** Tipo 100-foro Ø 24 mm / hole Ø 24 mm
- 410-007*** Tipo 150-foro Ø 40 mm / hole Ø 40 mm



Perforatore a colpo
Hole punch

- 420-000** Per Tipo 31-foro Ø 8 mm / hole Ø 8 mm
- 420-001** Per Tipo 40-foro Ø 10 mm / hole Ø 10 mm
- 420-002** Per Tipo 50-foro Ø 12 mm / hole Ø 12 mm
- 420-003** Per Tipo 60-foro Ø 14 mm / hole Ø 14 mm
- 420-004** Per Tipo 70-foro Ø 16 mm / hole Ø 16 mm
- 420-005** Per Tipo 80-foro Ø 18 mm / hole Ø 18 mm
- 420-006*** Tipo 100-foro Ø 24 mm / hole Ø 24 mm
- 420-007*** Tipo 150-foro Ø 40 mm / hole Ø 40 mm
- 420-100** Per bottone Perfix Ø 13 mm
For Perfix Button Ø 13 mm



Perforatore per anelle a vela
Hole punch for eyelet

- 431-000** Per Tipo 31-foro Ø 8 mm / hole Ø 8 mm
- 431-001** Per Tipo 40-foro Ø 10 mm / hole Ø 10 mm
- 431-002** Per Tipo 50-foro Ø 12 mm / hole Ø 12 mm
- 431-003** Per Tipo 60-foro Ø 14 mm / hole Ø 14 mm
- 431-004** Per Tipo 70-foro Ø 16 mm / hole Ø 16 mm
- 431-005*** Per Tipo 80-foro Ø 18 mm / hole Ø 18 mm
- 431-006*** Tipo 100-foro Ø 24 mm / hole Ø 24 mm
- 431-007*** Tipo 150-foro Ø 40 mm / hole Ø 40 mm

ACCESSORI PER CAPOTE

BIMINI TOP FITTING



202-1330

Basetta universale snodata con vite in acciaio AISI 316



202-1316

Basetta universale con vite in acciaio AISI 316



202-4801 IM

Basetta sganciabile in acciaio AISI 316



202-4801 S

Ricambio per 202-4801 spinotto a sfera



201-060

Basetta con attacco per tendalini in acciaio AISI 316 (2pz.)



202-1329

Supporto laterale piccolo con vite in acciaio AISI 316



202-1328

Supporto laterale grande con bullone in acciaio AISI 316



202-1586-22

Cappuccio rialzato ø 22 mm

202-1586-25

Cappuccio rialzato ø 25 mm



202-1600

Basetta per parabrezza piccola con bullone in acciaio AISI 316



202-1601

Basetta per parabrezza grande con bullone in acciaio AISI 316

Accessori per capote • *Bimini top fitting*

ACCESSORI PER CAPOTE

BIMINI TOP FITTING



202-1321

Basetta piatta 90° con perno in acciaio AISI 316



202-1317

Base piatta con vite 90° in acciaio AISI 316



202-1320

Base piatta inclinata a 60° con perno a molla in acciaio AISI 316



202-1319

Base inclinata a 60° con vite in acciaio AISI 316



202-1318

Base concava 90° in acciaio AISI 316



202-1324

Base concava 90° con perno in acciaio AISI 316



Terminale per tubo in acciaio AISI 316

203-1311 Ø 22mm

203-1313 Ø 25mm

203-1314 Ø 30mm



Cappuccio terminale per tubo a doppia vite in acciaio AISI 316

203-1501 Ø 25mm

203-1502 Ø 30mm

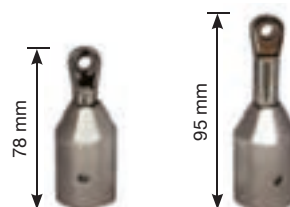

Cappuccio terminale con perno allungabile in acciaio AISI 316

203-1600IM Ø 22mm

203-1601IM Ø 25mm

203-1602IM Ø 30mm

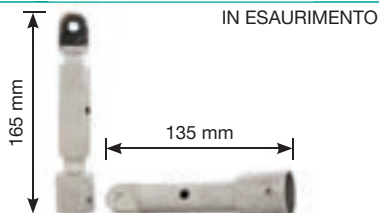

Cappuccio terminale estensibile in acciaio AISI 316

203-1722IM Ø 22mm

203-1725IM Ø 25mm

203-1730IM Ø 30mm



Snodo a 90° per tubo in acciaio AISI 316

205-1355 Ø 22mm

205-1356 Ø 25mm

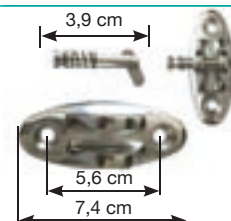

204-1412

Supporto a forcella base concava (2pz)

ACCESSORI PER CAPOTE

BIMINI TOP FITTING



Forcella per tubo con vite in acciaio AISI 316
204-1315 Ø 22mm
204-1316 Ø 25mm
204-1317 Ø 30mm
204-1317HV Ø 30mm (più massiccia)



Forcella per tubo apribile completo di viti in acciaio AISI 316
204-1400 Ø 22mm
204-1401 Ø 25mm
204-1402 Ø 30mm



Forcella per tubo apribile con spinotto rapido in acciaio AISI 316
204-1404 Ø 25mm
204-1405 Ø 30mm



Forcella per tubo apribile con spinotto rapido e leva acciaio AISI 316
204-1410 Ø 22mm
204-1411 Ø 25mm

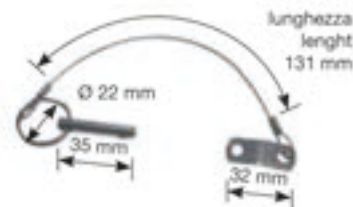

207-000
 Piastrina inox + cavetto inox Ø 1.6mm
 + spina inox con bloccaggio a sferetta



207-010
 Spinetta inox Ø 6mm con bloccaggio a sfera lungo 27mm



207-001
 Piastrina inox + cavetto inox Ø 1,6mm
 + spina inox con bloccaggio con linguetta pieghevole

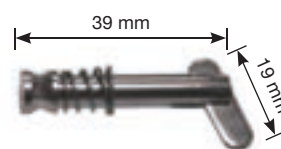

207-002
 Spinetta cavalletto reggi cappottina Ø 6mm in inox



202-1500
 Basetta grande a sfera in inox AISI 316 per 202-1502 e 1503



202-1501
 Forcella scorrevole grande a sfera in inox AISI 316 per 202-1502 e 1503



202-1502
 Cappuccio terminale a sfera inclinato a 90° in inox AISI 316 Ø 25mm

Accessori per capote • *Bimini top fitting*

ACCESSORI PER CAPOTE

BIMINI TOP FITTING



Cappuccio terminale a sfera in inox AISI 316 H6.8cm
Cappuccio terminale a sfera in inox AISI 36 H6.3cm

202-1503 Ø 25mm
202-1585-22 Ø 22mm
202-1585-25 Ø 25mm



202-1581
Basetta piccola concava a sfera in
inox AISI 316



202-1582
Basetta piccola piatta a sfera in inox
AISI 316



Forcella per tubo a sfera in inox AISI
316
202-1583-22 Ø 22mm
202-1583-25 Ø 25mm



Cappuccio piccolo a sfera a 90° in
inox AISI 316
202-1584-22 Ø 22mm
202-1584-25 Ø 25mm



28304 Piastrina in ottone con moschettone
28305 Piastrina con moschettone inox con base 5 mm
28302 Piastrina con moschettone inox con base 10 mm

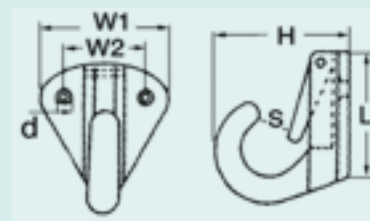

Materiale	L mm	W1 mm	W2 mm	S mm	D mm	H mm
28304	30	36	25	7	4,2	27
28305	27	33	20	7	4	25,5
28302	35	31	19	10	4,5	31,5

ACCESSORI PER CAPOTE

BIMINI TOP FITTING



202-1576
Terminali per rotaia



202-1577
Rotaia in acciaio AISI 316 lunga 120cm per montaggi orizzontali e verticali per 202-1578



202-1578
Cursore con basetta snodata



202-1575
Base con terminale girevole con fermo



202-1579
Base per terminale a sfera Ø 25mm



202-1574
Slitte in plastica per rotaia



202-1351
Rotaia in acciaio lunga 1mt e larga 29mm



202-1587
Snodo adattatore



202-1352
Terminale per rotaia in plastica nera per 202-1351



202-1352
Terminale per rotaia in plastica nera per 202-1351

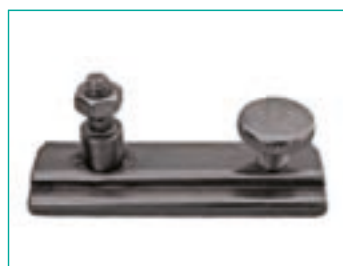

202-1354
Cursore con fermo a vite per montaggio laterale in acciaio per 202-1351

Ponticelli e moschettoni • Spring hooks

PONTICELLI E MOSCHETTONI

SPRING HOOKS

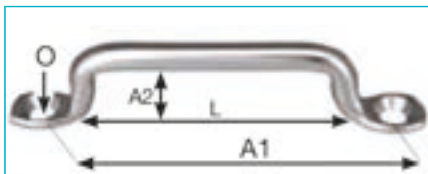

210-040

Ponticello inox h 25 mm per cinghia da 40 mm

	A1	A2	L	O
210-040	65 mm	7 mm	42 mm	3 mm

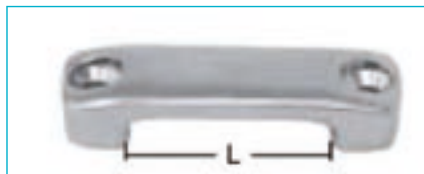

210-202

Ponticello rinforzato acciaio AISI 316 per cinghia da 40mm

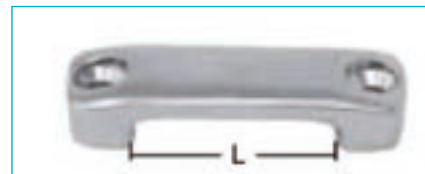

210-201

Ponticello rinforzato acciaio 316 per cinghia da 30 mm

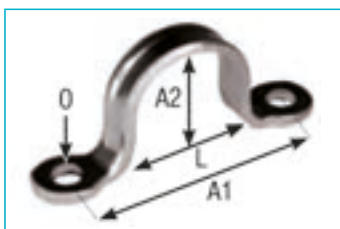

Ponticello curvo inox

	A1	A2	L	O
210-150	28	12	11	4
210-151	34	15	14	5
210-152	44	20	19	5



Moschettone acciaio AISI 316 spazzolato e lucidato

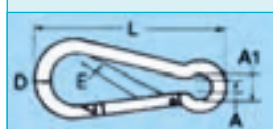

	D	L	ALL	A	E
211-050	5	50	10	6	8
211-060	6	60	13	8	9
211-070	7	70	13	8	9
211-080	8	80	13	8	9
211-100	10	100	16	10	12
211-120	12	120	18	11	16



Moschettone con foro in fusione, chiusura a molla in acciaio AISI 316

211-200 lunghezza 50 mm

211-201 lunghezza 70 mm



212-000

Moschettone in acciaio AISI 316 per tiranti tendalini - per cinghia da 25 mm



212-018

Moschettone in acciaio AISI 316 per tiranti - passo di 32 mm



211-250

Moschettone con asola girevole in acciaio AISI 316



212-005

Moschettone con fibbia regolabile in acciaio AISI 316 - passo da 25 mm

RINFORZI STRENGHTENINGS



28300

Calamita Neod molto resistente Ø 20 mm foro Ø 5,54 mm
Very resistant Neod magnet Ø 20 mm hole Ø 5,54 mm



28301

Gancio per selleria in INOX - 2 pezzi
Hook for upholstery steel - 2 pieces

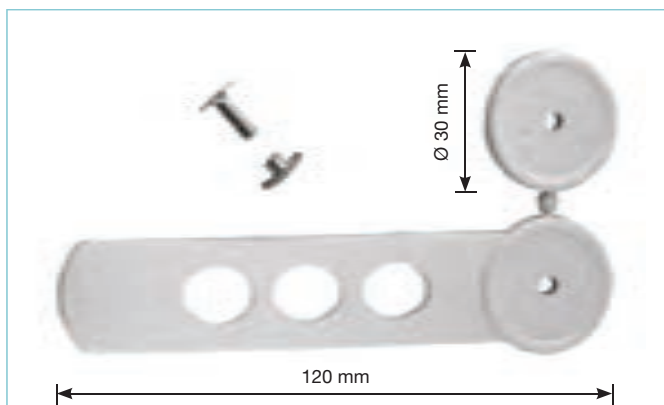

356-017

Rinforzo in PVC bianco - montaggio rapido senza cuciture
Quick installation with no sewing required and adjustable attachment

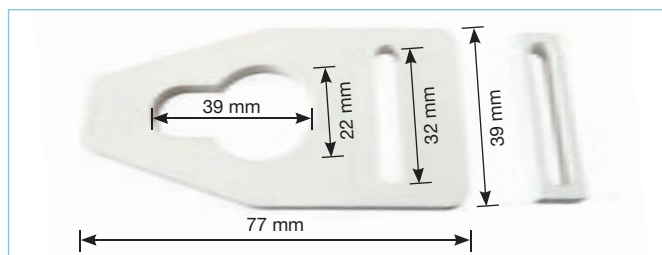
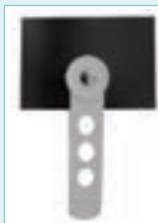

356-015

Fibbia passante per cinghia da 3cm con asola

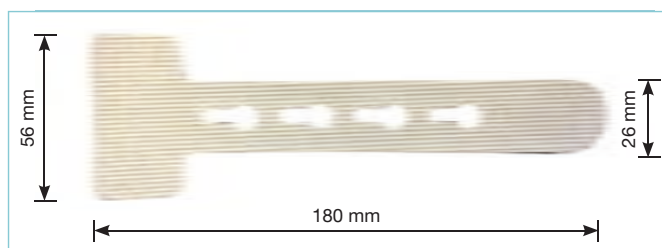

356-019

Cinturino telato regolabile col. bianco
Adjustable plastic strap col. white

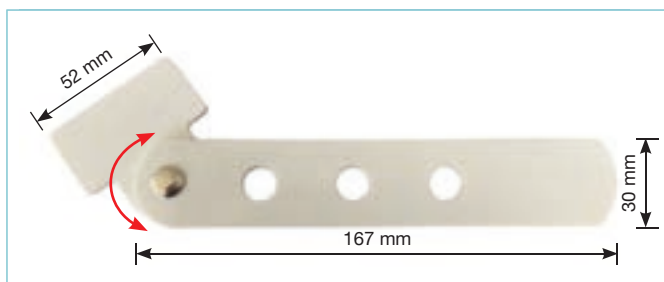

356-200

Cinturino in PVC ruotabile bianco con 3 fori
Rotatable PVC strap with 3 holes, white

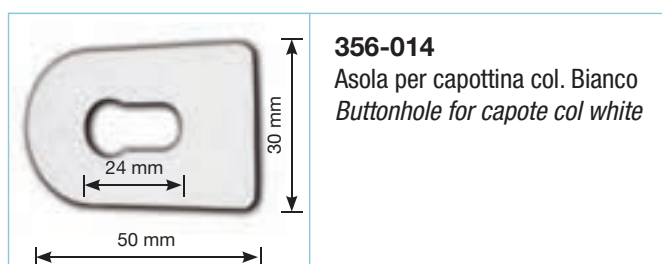

356-014

Asola per capottina col. Bianco
Buttonhole for capote col white

ACCESSORI IN PLASTICA

PLASTIC ACCESSORIES

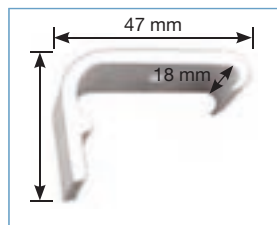

20008
Fermo per capottine
col. Bianco/nero
Fastener for capote
col. White/black

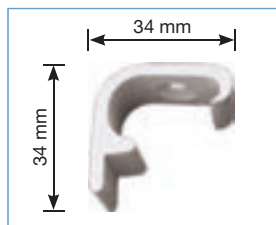

20009
Fermo per capottine
col. Bianco/nero
Fastener for capote
col. White/black



20012
Attacco per battagliola
col. bianco/nero
Base for rail col. white/
black



303-500
Tornichetto in Nylon (10pz) col.
bianco/nero
Nylon turn button (10pcs) col. white/
black



20013
Mini burchiello Ø 18mm col. bianco
Mini stud Ø 18 mm col. white



20024
Gancetto terminale foro Ø 6mm
(20pz) col. bianco/nero
Terminal hook hole Ø 6mm (20pcs)
col. white/black

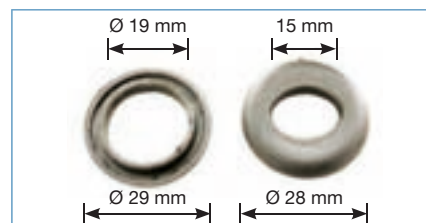

303-501
Asola tornichetto in nylon (2pz) col.
bianco/nero
Nylon grommer for turnbutton (2pcs)
col. white/black

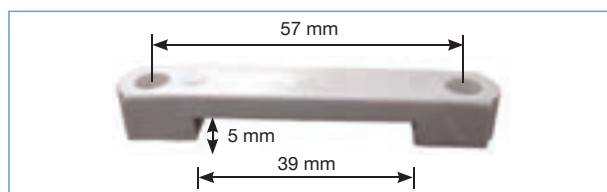

20033
Fissaggio per 20031 e 20032 col. bianco/*nero/*grigio
Fastener for 20031 and 20032 col. white/*black/*grey

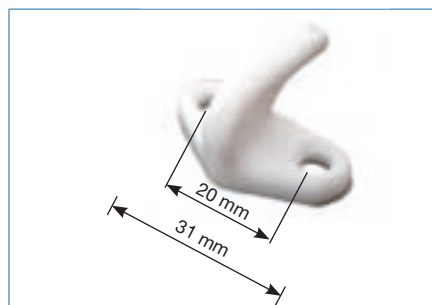

20029
Gancetto multiuso (20pz) col. bianco/
nero
Multipurpose hook (20pcs) col. white/
black

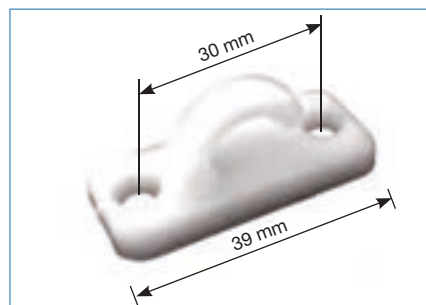

20030
Gancetto semi chiuso (20pz) col.
bianco/nero
Half opened hook (20pcs) col. white/
black

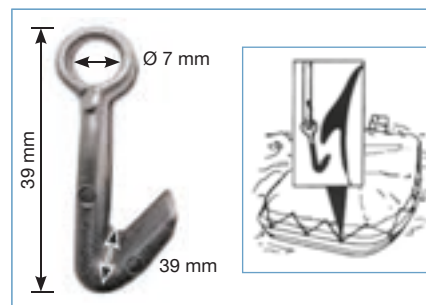

20280
Gancetto per gommoni (20pz) col.
bianco/grigio/nero
Nylon hook for dinghies (20pcs) col.
white/grey/black

ACCESSORI IN PLASTICA

PLASTIC ACCESSORIES



20032
Gancio per cinghia col.
bianco/*nero/*grigio
*Belt hook col.
white/*black/*grey*

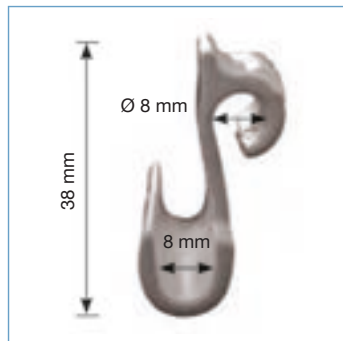

20031
Gancio per corda
elastica aperto col.
bianco/*nero/*grigio
*Hook for elastic cord col.
white/*black/*grey*



Moschettoni in nylon col. bianco/nero
Nylon hooks col. white/black
235-019 Ø 4mm
235-020 Ø 6mm
235-021 Ø 8mm
235-022 Ø 10mm



Rondella sottovite in nylon (100pz) col. bianco/nero/avorio
Washers (100pcs) col white/black/ivory
233-034 Ø 3.5mm
233-035 Ø 4.5mm
233-036 Ø 5.5 mm



Orli sottovite complete di
copritesta a scatto e collegato
alla base. Ø 3.5 mm / 4.2 mm
*Under screws with trigger
head cover connected to the
base. Ø 3.5 mm / 4.2 mm*
234-050 col. bianco/white
234-051 col. nero/black
234-052 col. marrone/brown



Copriviti in nylon (100pz) col. bianco/nero/avorio
Screw covers (100pcs) col. white/black/ivory
234-039 Ø 3.5 mm / 4.2 mm
234-040 Ø 4.8 mm / 6 mm



Sottovite inox piena
Stainless steel solid washer
233-049 M4
233-050 M5
233-051 M6

GN 4879		A1					
M	h	d1	d2	d3	d4	d5	h
mm	mm	mm	mm	mm	mm	mm	mm
M4	4,5	14	8,5	8,5	8,5	7,5	2,5
M5	5,5	16	11,5	10,4	10,4	2,8	2,8
M6	6,4	18	13,5	12,4	12,4	3,3	3,3

ACCESSORI IN PLASTICA

PLASTIC ACCESSORIES



20050
ponticello in nylon bianco - passo 50 mm



20101
Preso aria per capottine e teli ricovero col. bianco
Air intake for capote col. white



20099
Basetta in gomma per tendalini per gommoni col. nero/grigio
Rubber base for awning col. black/grey



20102
Preso d'aria circolare adesiva per film termoretraibile - colore bianco
Circular adhesive air intake for shrink film - col. white



20100
Appoggio per teloni ricovero in moplen per 20200 Ø 20mm col. bianco
Moplen support for canopy for 20200 Ø 20mm col. white



20103
Preso d'aria a perforazione film termoretraibile - colore bianco
Perforating air intake for shrink film - col. white

ACCESSORI IN PLASTICA

PLASTIC ACCESSORIES



20104
Aeratore per teloni
copri scafo -
colore nero
*Air intake for
covering canopy -
col. black*



554-001
Anelli in silicone Ø
50 mm
*Silicone ring Ø 50
mm*



20201
Aste per supporto teloni allungabile
75-120 cm, completa di appoggio
circolare bianco e tappo
*Telescopic pole for boat covers
75-120 cm, with circular support
and closing cap*

20202
Aste per supporto teloni allungabile
90-160 cm, completa di appoggio
circolare bianco e tappo
*Telescopic pole for boat covers
90-160 cm, with circular support
and closing cap*

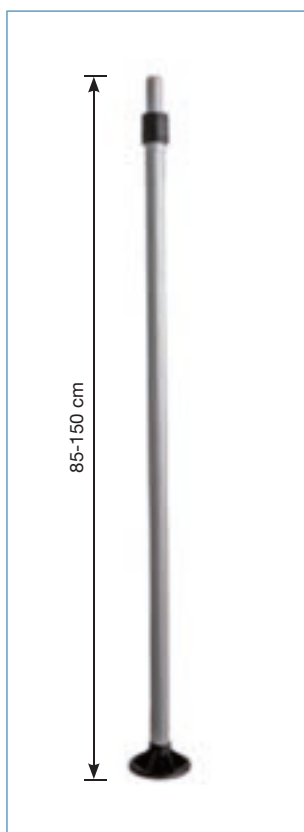

20200
Asta per articolo 20100,
completa di base in gomma di
colore nero
*Boat covers support pole, with
rubber black base*



Aste telescopiche per teloni
Telescopic pole for boat covers

20043
58 - 102 cm

20044
86 - 150 cm

20045
108 - 200 cm

Funghetti ferma teloni • *Lashing button*

FUNGHETTI FERMA TELONI

LASHING BUTTONS



355-200

Funghetto ferma teloni in acciaio inox h10mm Ø 12mm
Lashing button stainless steel h10mm Ø 12mm



355-201

Funghetto ferma teloni in acciaio inox h13mm Ø 12mm
Lashing button stainless steel h13mm Ø 12mm



355-100

Funghetto ferma teloni in alluminio h10mm Ø 3mm
Lashing button in aluminium h10mm Ø 3mm



355-202

Funghetto ferma teloni in acciaio AISI 316 h19mm Ø 5mm
Lashing button stainless steel AISI 316 h19mm Ø 5mm



355-203

Funghetto ferma teloni testa grande in acciaio AISI 316 h12.5mm Ø 19mm
Big lashing button stainless steel AISI 316 h12.5mm Ø 19mm



355-010

Funghetto a goccia in nylon bianco 13mm
Drop lashing button in white nylon 13mm



355-001

Funghetto ferma teloni testa grossa in plastica h9mm Ø 2mm col. bianco/nero
Big plastic lashing button h9mm Ø 2mm col. white/black

FIBBIE E FERMACORDA

BUCKLES AND CORD LOCK



319-000

Ferma corda in nylon a molla Ø 4mm col. bianco/nero
Cord lock with spring Ø 4mm col. white/black



319-010

Ferma corda quadrato in plastica Ø 4mm col. bianco/nero
Plastic square cord lock Ø 4mm col. white/black



319-020

Ferma corda piatto doppio foro in plastica Ø 4mm col. bianco/nero
Plastic flat cord lock Ø 4mm col. white/black



230-030

Fibbia triangolare in nylon lato 30mm col. bianco/nero
Triangular nylon buckle side 30mm col. white/black



Fibbia aprile in acetato
Acetate openable buckle

232-025 N 25 mm nero / black

232-025 B 25 mm bianco / white

232-030 N 30 mm nero / black

232-030 B 30 mm bianco / white

232-040 N 40 mm nero / black

232-040 B 40 mm bianco / white

232-050 N 50 mm nero / black

232-050 B 50 mm bianco / white

Fibbie e fermacorda • Buckles and cord lock

FIBBIE E FERMACORDA

BUCKLES AND CORD LOCK



230-002

Fibbia con passanti regolabile h30mm
(10pz) col. bianco/nero
*Plastic buckle awning h30mm (10pcs)
col. white/black*

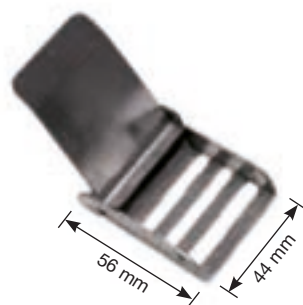

230-400

Fibbie regolabili inox passaggio per
cinghie fino a 40mm
*Adjustable stainless-steel buckle
maximum 40mm large*



230-510

Fibbia in acciaio aisi 316 con apertura
a molla per cinghia fino a 25mm

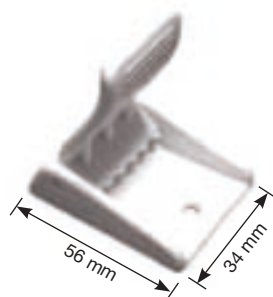

230-001

Fibbia per tendalino in plastica fisso
h30mm (10pz) col. bianco/nero
*Plastic buckle awning h30mm (10pcs)
col. white/black*



230-120

Fibbia in nylon su placca a due fori
per cinghia da 20 mm col. Bianco/
nero



210-122

Fibbia in nylon con foro per cinghia da
20 mm col. bianco/nero



210-125

Fibbia in nylon per cinghia da 25 mm
col. Bianco/nero



230-003

Fibbia in nylon per cinghia da 30 mm
col. Bianco/nero



230-004

Fibbia in nylon per cinghia da 40 mm
col. Bianco/nero

FIBBIE E FERMACORDA

BUCKLES AND CORD LOCK

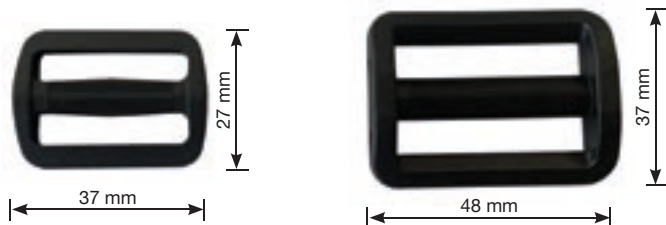

Fibbia passante in plastica
Plastic passing through buckle
230-061 N* 30 mm nero / black
230-061 B* 30 mm bianco / white
230-062 N* 40 mm nero / black
230-062 B* 40 mm bianco / white

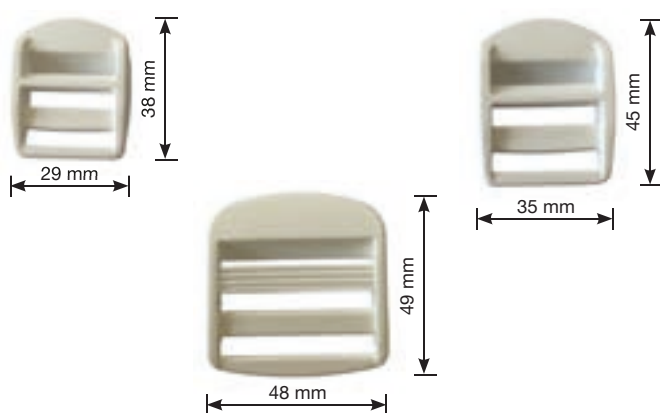

Fibbia passante in acetate / *Acetate passing through buckle*
230-051 N per cinghia da 25 mm col. nero
for belt till 25 mm col. black
230-051 B per cinghia da 25 mm col. bianco
for belt till 25 mm col. white
230-052 N per cinghia da 30 mm col. nero
for belt till 30 mm col. black
230-052 B per cinghia da 30 mm col. bianco
for belt till 30 mm col. white
230-053 N per cinghia da 40 mm col. nero
for belt till 30 mm col black
230-053 B per cinghia da 40 mm col. bianco
for belt till 40 mm col. white



Fibbia in inox / *Inox buckle with bar*
230-300 per cinghia fino a 25 mm
for belt till 25 mm
230-300L per cinghia fino a 25 mm
(più leggero)
for belt till 25 mm (more light)
230-301 per cinghia fino a 40 mm
for belt till 40 mm
230-302* per cinghia fino a 50 mm
for belt till 50 mm



Fibbia inox a tre passaggi
Stainless steel buckle with three passing through
230-089 per cinghia da 30 mm
for belt till 30 mm
230-090 per cinghia da 40 mm
for belt till 40 mm
230-091 per cinghia da 50 mm
for belt till 50 mm



230-105
 Fibbia passante in inox con blocco a molla per cinghia fino a 25 mm
Stainless-steel passing through with spring stop for belt till 25 mm

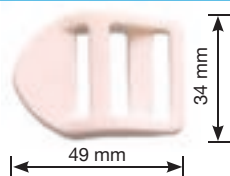

230-074
 fibbia passante in acetato per cinghia fino a 25 mm col bianco/nero
Acetate passing through for belt till 25 mm col. B white / N black



230-075
 Fibbia passante in acetato per cinghia fino a 35 mm col B bianco / N nero
Acetate passing through for belt till 35 mm col. B white / N black

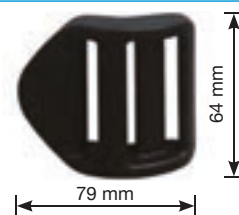

230-076
 Fibbia passante in acetato per cinghia fino a 50 mm col. N nero / B bianco
Acetate passing through for belt till 50 mm col. N black / B white

PROFILI E ACCESSORI

PROFILES AND ACCESSORIES

 <p style="text-align: right;">Ø 9 mm</p>	<p>Barre profilo in alluminio con sezione a C <i>Section C profile - aluminium bar</i></p> <p>26000 lunghezza / length 2mt 26001 lunghezza / length 3mt 26002 lunghezza / length 4mt</p>
--	---

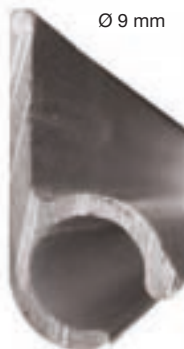
 <p style="text-align: right;">Ø 9 mm</p>	<p>Barre profilo in alluminio con sezione a C e con ala per fissaggio <i>Section C profile with tab - aluminium bar</i></p> <p>26100 lunghezza / length 2mt 26101 lunghezza / length 3mt 26102 lunghezza / length 4mt</p>
---	--

 <p style="text-align: right;">Ø 9 mm</p>	<p>Barre profilo in alluminio verniciato bianco con sezione a C e ala di fissaggio <i>Section C profile with tab - aluminium white paint bar</i></p> <p>26102B lunghezza / length 4mt 26100B lunghezza / length 4mt</p>
--	--

 <p style="text-align: right;">Ø 9 mm</p>	<p>26600 Barra profilo in plastica bianca o nera sezione a C barre da 4 mt <i>Section C profile white or black plastic bar length 4mt</i></p>
--	--

 <p style="text-align: right;">Ø 9 mm</p>	<p>26700 Profilo in plastica bianca con ala lunghezza 4mt <i>Section C profile with tab - white plastic length 4mt</i></p>	
--	---	---

PROFILI E ACCESSORI

PROFILES AND ACCESSORIES



Tondino rivestito con due ali saldate per profili in rotoli
Coated tube with two tabs
26297 Ø 5mm rotoli da / rolls 100mt
26299 Ø 6mm rotoli da / rolls 100mt
26300 Ø 7.5mm rotoli da / rolls 50mt
26300T Ø 7.5mm con anima trasparente, rotoli da / rolls 50mt, *transparent inside*
26301 Ø 8.5mm rotoli da / rolls 50mt



Tondino senza ali per profili sezione a C in rotoli da 300mt = 15kg
Pvc tube for section C profile rolls 300mt = 15kg
26399 Ø 6.5mm
26400 Ø 7mm
26401 Ø 8mm

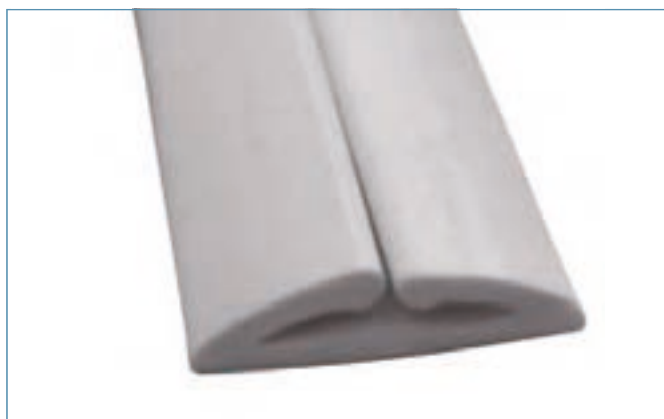

260-001
 Bordino copri punti col. bianco / avorio / altri colori su ordinaz.
Flat band to mask staples col. white / ivory / other colours on demand



260-101
 Bordino in pvc con aletta 10mm per finiture Ø 4mm col. bianco / rosso / nero / grigio
Pvc round band with tab 10mm Ø 4mm col. white / red / black / grey



260-201
 Tondino in pvc da rivestire Ø 3mm
Pvc tube Ø 3mm

YKK cerniere e cursori • YKK zippers and sliders

YKK CERNIERE E CURSORI

YKK ZIPPERS AND SLIDERS



YKK cerniera divisibile con cursore a 2 tretti autobloccante in zama verniciato in tinta su catena plastica pressofusa da 8mm. Col. bianco / nero / grigio / altri colori su ordinazione
YKK opened zipper with double faced slider colour matched 8mm painted Col. white / black / grey / other colours on demand

- 519-100** lunghezza / length 100cm
- 519-150** lunghezza / length 150cm
- 519-200** lunghezza / length 200cm
- 519-250** lunghezza / length 250cm
- 519-300** lunghezza / length 300cm
- 519-350** lunghezza / length 350cm
- 519-400** lunghezza / length 400cm



YKK cerniera divisibile con cursore a 2 tretti in zama verniciato in tinta libero su catena plastica pressofusa da 8mm. Col. bianco / nero / blu navy / beige / grigio / altri colori su ordinazione
YKK opened zipper with double faced slider colour matched 8mm painted Col. white / black / navy blue / beige / grey / other colours on demand

- 520-050** lunghezza / length 50cm
- 520-080** lunghezza / length 80cm
- 520-100** lunghezza / length 100cm
- 520-120** lunghezza / length 120cm
- 520-150** lunghezza / length 150cm
- 520-180** lunghezza / length 180cm
- 520-200** lunghezza / length 200cm
- 520-250** lunghezza / length 250cm
- 520-280** lunghezza / length 280cm
- 520-300** lunghezza / length 300cm
- 520-350** lunghezza / length 350cm
- 520-400** lunghezza / length 400cm
- 520-450** lunghezza / length 450cm
- 520-500** lunghezza / length 500cm
- 520-550** lunghezza / length 550cm
- 520-600** lunghezza / length 600cm

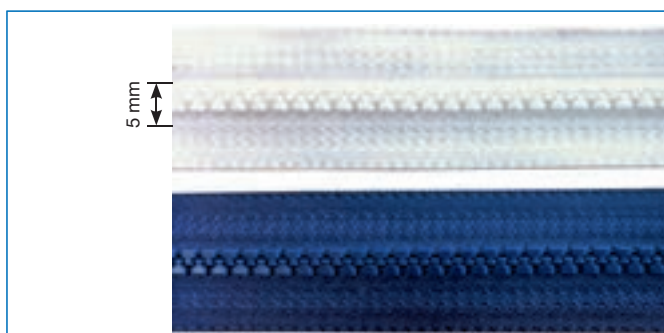

YKK cerniera divisibile in plastica pressofusa da 5mm con cursore doppio tiretto in plastica. Altre dimensioni su ordinazione. Col. bianco / blu / nero / beige / grigio
YKK plastic opened zipper with plastic double face slider 5mm. Different measures on demand. Col white/ blue / black / beige / grey

- 525-050** lunghezza / length 50cm
- 525-100** lunghezza / length 100cm
- 525-150** lunghezza / length 150cm
- 525-200** lunghezza / length 200cm
- 525-250** lunghezza / length 250cm
- 525-300** lunghezza / length 300cm
- 525-350** lunghezza / length 350cm



520-001
 YKK fermi superiori in nickel per cerniera divisibile da 8mm (2pz in coppia)
YKK tab in nickel for zipper 8mm width (2pcs/couple)

YKK CERNIERE E CURSORI

YKK ZIPPERS AND SLIDERS

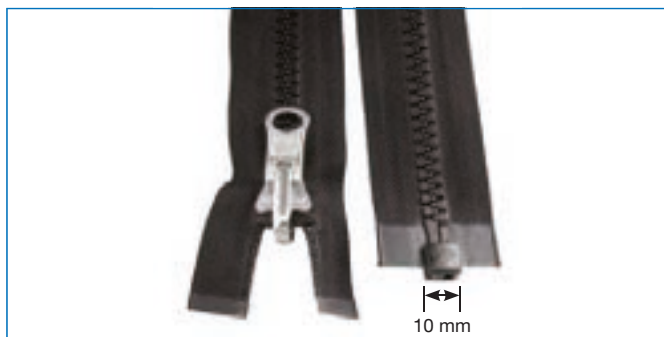

YKK cerniera divisibile con cursore 1 tiretto autobloccante reversibile in zama nichelato su catena in plastica pressofusa da 8 mm. Col. bianco / nero / altri colori su ordinazione
YKK plastic opened zipper 8 mm large, with automatic lock and reversible slider nickel plated. Col. white / black / different colours on demand

- 522-050 lunghezza / length 50cm
- 522-080 lunghezza / length 80cm
- 522-100 lunghezza / length 100cm
- 522-120 lunghezza / length 120cm
- 522-150 lunghezza / length 150cm
- 522-180 lunghezza / length 180cm
- 522-200 lunghezza / length 200cm
- 522-250 lunghezza / length 250cm
- 522-300 lunghezza / length 300cm
- 522-350 lunghezza / length 350cm
- 522-400 lunghezza / length 400cm
- 522-450 lunghezza / length 450cm



YKK cerniera divisibile con cursore 2 tiretti in plastica autobloccante in tinta su catena in plastica pressofusa da 10 mm. Col. bianco / nero / blu navy / beige / altri colori su ordinazione
YKK plastic opened zipper 10 mm large painted with plastic double face slider with automatic lock. Col. white / black / navy blue / beige / other colours on demand

- 526-050 lunghezza / length 50cm
- 526-080 lunghezza / length 80cm
- 526-100 lunghezza / length 100cm
- 526-120 lunghezza / length 120cm
- 526-150 lunghezza / length 150cm
- 526-200 lunghezza / length 200cm
- 526-250 lunghezza / length 250cm
- 526-300 lunghezza / length 300cm
- 526-350 lunghezza / length 350cm
- 526-400 lunghezza / length 400cm
- 526-450 lunghezza / length 450cm
- 526-500 lunghezza / length 500cm
- 526-550 lunghezza / length 550cm
- 526-600 lunghezza / length 600cm
- 526-700 lunghezza / length 700cm
- 526-750 lunghezza / length 750cm
- 526-1000 lunghezza / length 10mt
- 526-1200 lunghezza / length 12mt
- 526-1500 lunghezza / length 15mt



YKK cerniera divisibile con cursore 1 tiretto autobloccante reversibile in zama in tinta su catena in plastica verniciata pressofusa da 8 mm Col. bianco / nero / blu 919/ grigio / altri colori su ordinazione

- 523-100 lunghezza / length 100cm
- 523-150 lunghezza / length 150cm
- 523-200 lunghezza / length 200cm
- 523-250 lunghezza / length 250cm
- 523-300 lunghezza / length 300cm



526-001
 YKK fermi superiori in nichel per cerniera divisibile da 10 mm (2pz in coppia) / *YKK tab nickel plated for zipper 10mm width (2pcs/couple)*

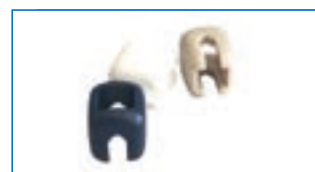

526-002
 YKK fermi superiori in plastica per cerniera divisibile da 10 mm (2pz in coppia) / *YKK tab in plastic for zipper 10mm width (2pcs/couple)*

YKK cerniere e cursori • YKK zippers and sliders

YKK CERNIERE E CURSORI

YKK ZIPPERS AND SLIDERS



499-001

YKK infila cursori da banco piccolo per cursore da 3 e 5mm
YKK slider machine for slider from 3 to 5mm

499-002

YKK infila cursori da banco grande per cursore da 8 e 10mm
YKK slider machine for sliders from 8 to 10mm

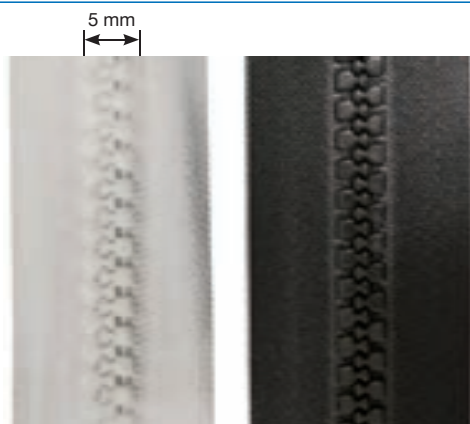

500-000

YKK Cerniera a catena in rotoli in plastica pressofusa a catena di 5mm. Rotoli da 200mt Col. bianco / nero / blu / beige /altri colori su ordinazione per min. 1 rotolo
YKK zipper plastic chain 5mm large roll of 200mt painted.
Col. white / black / blue / grey / other colours on demand minimum 1 roll



500-151

Cursore 1 tiretto in plastica autobloccante Col. bianco / blu navy / nero
Plastic automatic lock slider single tab Col. white / navy blue / black



500-101

Cursore 1 tiretto in zama verniciato autobloccante Col. bianco / nero / altri colori su ordinazione
Automatic lock slider single tab Col. white / black / other colours on demand



500-162

Cursore 2 tiretti in plastica autobloccante Col. bianco / blu navy / nero
Plastic double face automatic lock slider Col. white / navy blue / black

YKK CERNIERE E CURSORI

YKK ZIPPERS AND SLIDERS

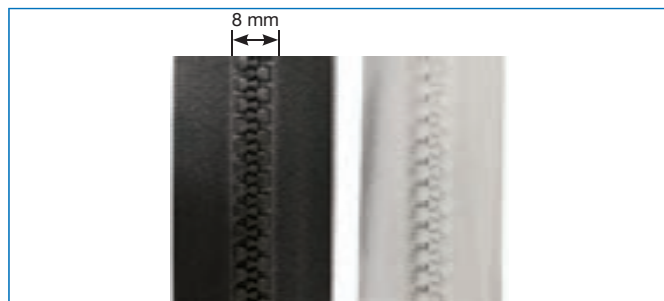

501-000

YKK cerniera in plastica pressofusa a catena di 8mm. Rotoli da 100mt. Col. bianco / nero / blu / beige / altri colori su ordinazione per min. 1 rotolo
YKK plastic chain 8mm large painted in rolls of 100mt. Colours white / black / blue / beige / other colours on demand minimum 1 roll



501-101

Cursore 1 tiretto in zama verniciato autobloccante. Col. bianco / nero / beige / grigio / blu / altri colori su ordinazione
Automatic lock slider single tab painted. Col. white / black / beige / gray / blue / other colours on demand



501-151

Cursore 1 tiretto in plastica autobloccante. Col. bianco / blu navy / nero / altri colori su ordinazione
Plastic automatic lock slider single tab. Col white / navy blue / black / other colours on demand



501-202

Cursore 1 tiretto reversibile autobloccante in zama nichelato
Automatic lock reversible slider nickel plated



501-203

Cursore 1 tiretto reversibile autobloccante in zama colorato. Col. bianco / nero / blu / grigio / altri colori su ordinazione
Automatic lock reversible slider painted Col. white / black / blue / gray / other colours on demand



501-112

Cursore 2 tiretti in zama verniciato libero. Col. bianco / nero / altri colori su ordinazione
Double faced non lock slider painted two tabs. Col. white / black / other colours on demand



501-212

Cursore 2 tiretti in zama nichelato libero
Double faced non lock slider nickel plated two tabs

YKK CERNIERE E CURSORI

YKK ZIPPERS AND SLIDERS

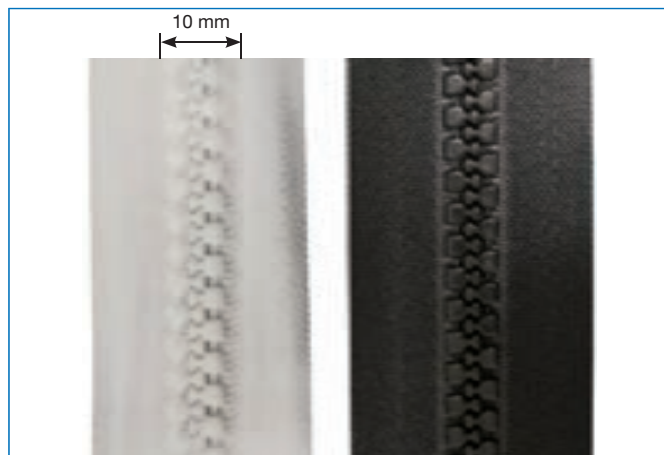

502-000

YKK cerniera in plastica pressofusa a catena di 10mm. Rotoli da 100mt. Col. bianco / nero / blu / beige / altri colori su ordinazione per min. 1 rot.

YKK painted plastic chain 10mm large in rolls of 100mt. Col. white / black / blue / beige / other colours on demand minimum 1 roll



502-101

Cursore 1 tiretto in zama verniciato autobloccante Col. bianco / nero / blu / altri colori su ordinazione

Automatic lock slider single tab painted Col. white / black / blue / other colours on demand

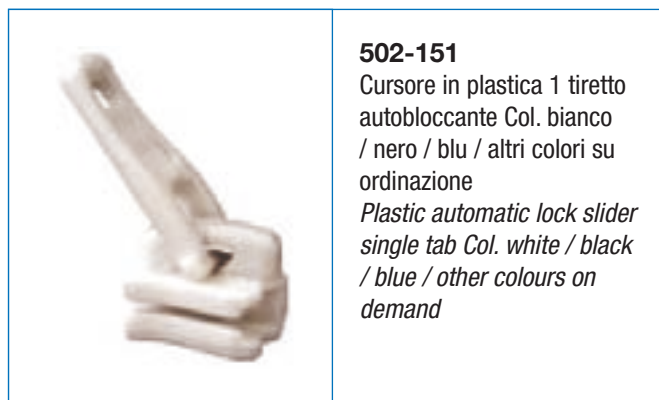

502-151

Cursore in plastica 1 tiretto autobloccante Col. bianco / nero / blu / altri colori su ordinazione

Plastic automatic lock slider single tab Col. white / black / blue / other colours on demand



502-112

Cursore a 2 tiretti in zama verniciato libero Col. bianco / nero / blu / altri colori su ordinazione

Double faced non lock slider 2 tabs painted Col. white / black / blue / other colours on demand



502-212

Cursore 2 tiretti in zama nichelato libero

Double faced non lock slider nickel plated



502-162

Cursore in plastica 2 tiretti autobloccante Col. bianco / blu / altri colori su ordinazione

Plastic double face automatic lock slider Col. white / blue / other colours on demand



502-204

Cursore 2 tiretti autobloccanti in zama verniciato col. Beige, bianco, blu, nero

Automatic lock slider with 2 tabs painted col. Beige, white, blu, black

YKK CERNIERE E CURSORI

YKK ZIPPERS AND SLIDERS

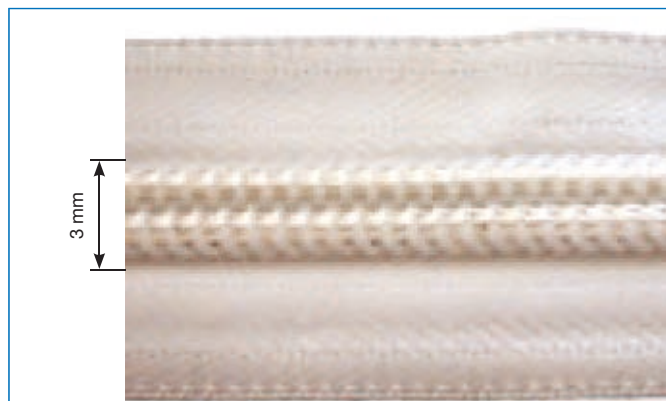

510-000

YKK cerniera a spirale in nylon a catena di 3 mm. Rotoli da 200mt Col. bianco / nero / blu / beige / avorio / altri colori su ordinazione minimo 1 rotolo
YKK spiral chain 3 mm large. Rolls 200mt Col. white / black / blue / beige / ivory / other colours on demand minimum 1 roll



510-101

Cursore base in zama verniciato autobloccante Col. bianco / nero / altri colori su ordinazione
Automatic lock slider painted Col. white / black / other colours on demand



510-151

Cursore 1 tiretto libero in plastica col. bianco
Plastic automatic lock slider single tab col. white



511-000

YKK cerniera spirale nylon a catena di 5 mm rotoli da 200mt Col. bianco / nero / blu / beige / avorio / altri colori su ordinazione minimo un rotolo
YKK spiral chain 5 mm large rolls 200mt Col. white / black / blue / beige / ivory / other colours on demand minimum one roll



511-101

Cursore base in zama verniciato autobloccante Col. bianco / nero / altri colori su ordinazione
Automatic lock slider single tab painted Col. white / black / other colours on demand



511-102

Cursore a 1 tiretto lungo e libero in zama verniciato
Non lock single long tab painted

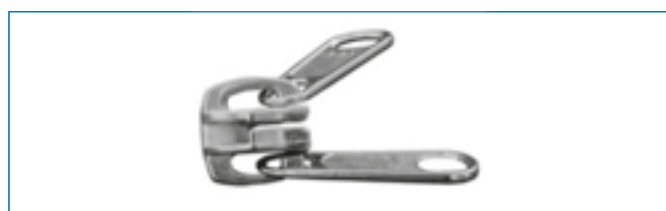

511-212*

Cursore due tiretti in zama nichelato libero
Double faced non lock slider nickel plated



511-151

Cursore 1 tiretto in plastica libero Col. bianco / altri colori su ordinazione
Plastic automatic lock slider single tab Col. white / other colours on demand

YKK cerniere e cursori • YKK zippers and sliders

YKK CERNIERE E CURSORI

YKK ZIPPERS AND SLIDERS



512-000

YKK cerniera spirale nylon a catena di 8 mm rotoli da 100 mt Col. bianco / nero / blu / beige / avorio / altri colori su ordinazione minimo 1 rotolo
YKK spiral chain 8mm large rolls 100mt Col. white / black / blue / beige / ivory / other colours on demand minimum 1 roll



512-112

cursore 2 tiretti in zama verniciato libero Col bianco / nero / altri colori su ordinazione
Double faced non lock slider painted Col. white / black / other colours on demand



512-101

Cursore libero in zama verniciato a un tiretto Col. bianco / nero
Free slider with one slider painted Col. white / black

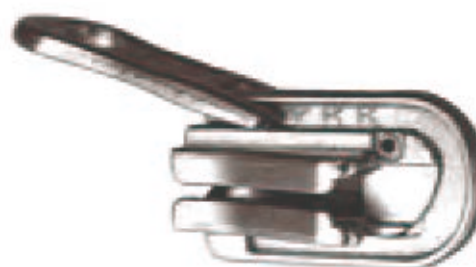

512-202

Cursore 1 tiretto reversibile in zama nichelato autobloccante
Automatic lock reversible slider nickel plated



512-102

Cursore tiretto lungo in zama verniciato libero Col. bianco / nero / altri colori su ordinazione
Non lock single long tab painted Col. white / black / other colours on demand

YKK CERNIERE E CURSORI



YKK ZIPPERS AND SLIDERS

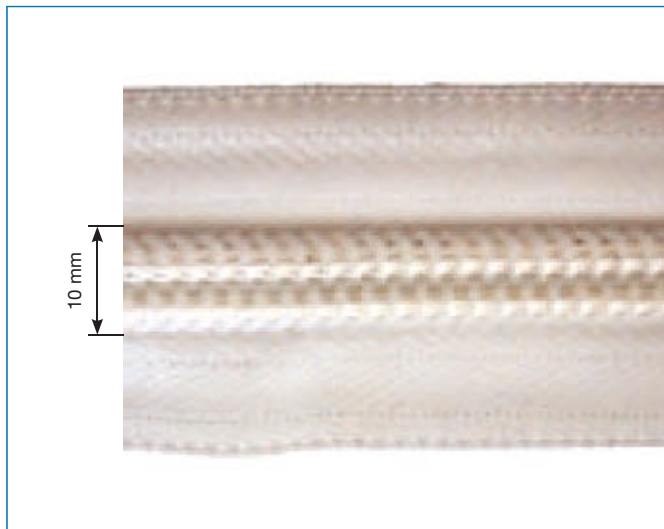

513-000

YKK cerniera spirale nylon a catena di 10 mm in rotoli da 100 mt Col. bianco / nero / altri colori su ordinazione minimo 1 rotolo

YKK spiral chain 100mm large in rolls of 100mt Col white / black / other colours on demand minimum 1 roll



513-112

Cursore a 2 tiretti in zama verniciato libero Col. bianco / nero / altri colori su ordinazione

Double faced non lock slider two tabs painted Col. white / black / other colours on demand



513-101

Cursore base in zama verniciato autobloccante Col. bianco / nero / altri colori su ordinazione

Automatic lock slider painted Col. white / black / other colours on demand

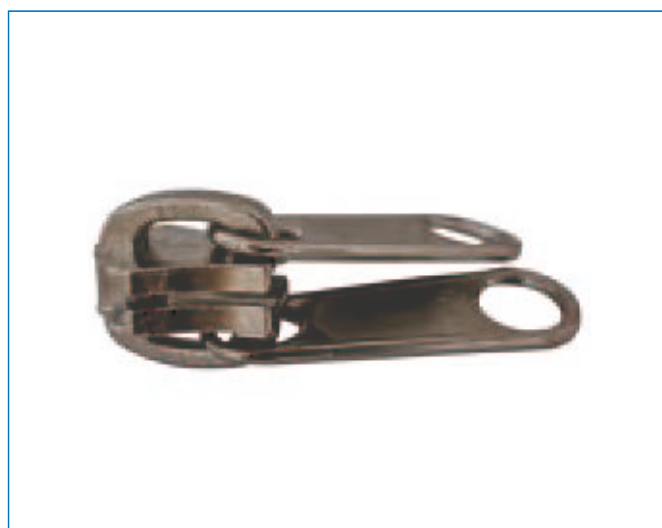

513-212

Cursore 2 tiretti in zama nichelato libero

Double faced non lock slider 2 tabs nickel plated

Colle • Glues

COLLE GLUES



Contenitore per colla con pennello
Glue box with brush

561-000 piccolo / *little* 0.4L
561-001 medio / *medium* 0.9L



561-010
Spalmacolla a pressione con pennello
Glue pump with brush



561-015
Ricambio pennello spalmacolla per 561-010 (10pz)
Spare brush for glue pump for 561-010 (10pcs)



560-501
Bomboletta di colla Spray multiuso da 400ml. Indicata per effettuare molti tipi di incollaggi rapidi e sicuri. Adatto per carta, cartone, legno, stoffa, imbottiti, tessuti, pelle, plastica, lana di roccia, fibre di vetro, materiali assorbenti, ecc. Buona resistenza alle temperature. La bomboletta ha una valvola che permette la regolazione dello spruzzo in senso verticale ed orizzontale.
Spray glue for many type of bonding, fast and secure. Appropriate for paper, cardboard, wood, fabric, upholstery, leather, plastic, rock wool, glass fibres, absorbent materials in general, etc. Good temperature resistant. Equipped with a special valve that allows the adjustment of the spray vertically or horizontally.



Colla neoprenica resistente al calore
Neoprene liquid glue warm resistant
560-602 Colla a pennello da 0.85kg
Handle paint glue 0.850kg
560-606 Colla a pennello da 4.5kg
Handle paint glue 4.5kg
560-617 Colla a pennello da 15kg
Handle paint glue 15kg
560-706 Colla a spruzzo da 4.5kg
Spray glue 4.5kg
560-717 Colla a spruzzo 20kg
Spray glue 20kg



560-801
Colla ad acqua per uso nautico.
Confezione da 5kg
Water-based glue for marine use
560-802
Colla ad acqua per uso nautico.
Confezione da 10kg
Water-based glue for marine use
560-803
Colla ad acqua per uso nautico.
Confezione da 20kg
Water-based glue for marine use

VELCRO

VELCRO



***YKK nastro a strappo adesivo**

(solo su ordinazione)

***YKK adhesive velcro tape**

(only on demand)

YKK nastro a strappo (disponibili a magazzino nei

colori bianco / nero / beige / blu / altri colori su ordinazione)

YKK velcro tape (colours on stock white / black / beige /

blue / other colours on demand)

Uncino / hook

- 550-100** h 20 mm
- 550-102** h 25 mm
- 550-104** h 30 mm
- 550-106** h 38 mm
- 550-108** h 50 mm
- 550-110** h 100 mm

Asola / loop

- 550-101** h 20 mm
- 550-103** h 25 mm
- 550-105** h 30 mm
- 550-107*** h 38 mm
- 550-109** h 50 mm
- 550-111*** h 100 mm

Uncino / hook

- 550-000** h 20 mm
- 550-002** h 25 mm
- 550-004** h 30 mm
- 550-006*** h 38 mm
- 550-008** h 50 mm
- 550-010** h 100 mm

Asola / loop

- 550-001** h 20 mm
- 550-003** h 25 mm
- 550-005** h 30 mm
- 550-007*** h 38 mm
- 550-009** h 50 mm
- 550-011** h 100 mm

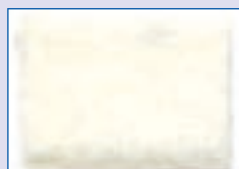

501

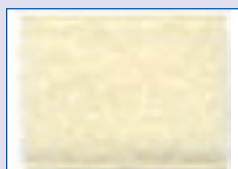

841*

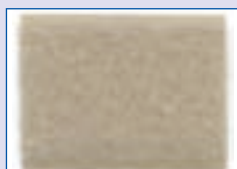

572

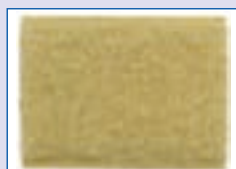

C001*

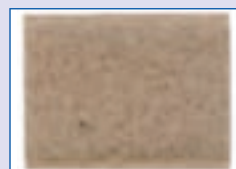

573*

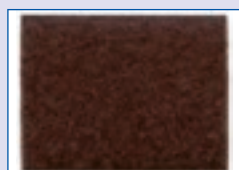

570*

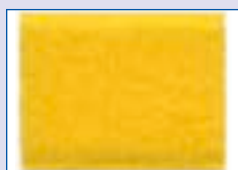

506*

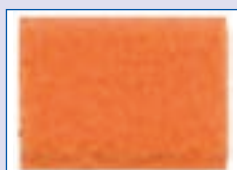

523*

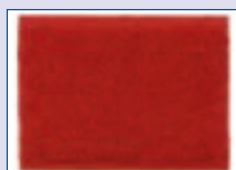

519*

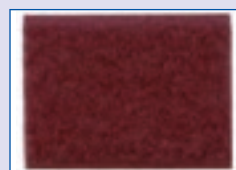

527*

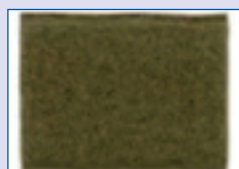

566*

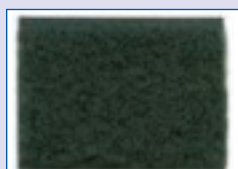

530*

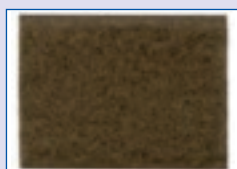

078*

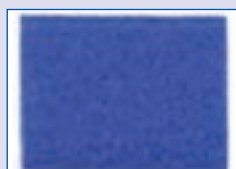

918*

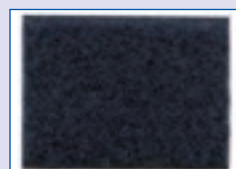

560

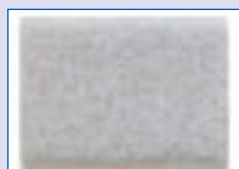

119*



576*

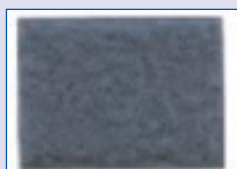

578*

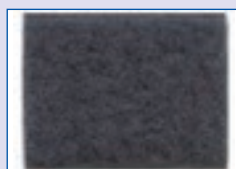

389*

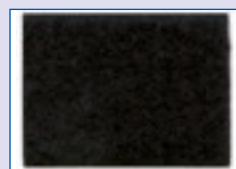

580

Fissaggi per tappezzeria • Fixings for upholstery

FISSAGGI PER TAPPEZZERIA

FIXINGS FOR UPHOLSTERY

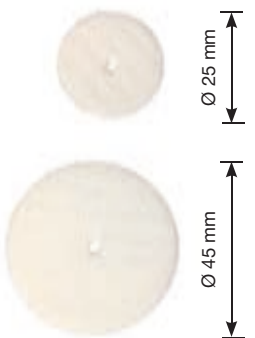

549-000
Uncino Ø 25 mm col. bianco /
nero
*Hook disc Ø 25 mm col. white /
black*

549-110
Uncino Ø 45 mm colore bianco
Hook Ø 45 mm white color



549-001
Asola Ø 25 mm colore bianco
Loop Ø 25 mm white color

549-101
Asola Ø 45 mm colore bianco
Loop Ø 45 mm white color



Uncino Ø 45 mm in fusione unica
Hook disc Ø 45 mm
549-100 col. bianco / *white*
549-100 col. **580** nero / *black*

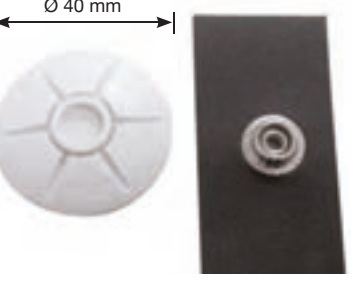

Parte B / *B part*
320-100 PLB 40
Piastra circolare Ø 40
mm adesiva in plastica
bianca / nera con molla
automatico incorporata
(parte B)
*Circular adhesive white /
black plastic plate Ø 40
mm with socket (B part)*

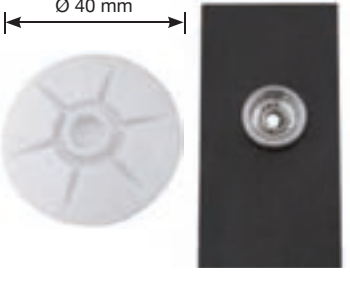

Parte C / *C part*
320-200 PLB 40
Piastra circolare Ø 40
adesiva in plastica
bianca / nera con
maschio automatico
incorporato (parte C)
*Circular adhesive white
/ black plastic plate with
stud Ø 40 (B part)*

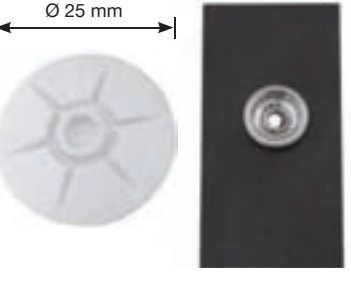

Parte C / *C part*
320-200 PLB 25
Piastra circolare Ø 25
mm adesiva in plastica
bianca con maschio
automatico incorporato
(parte C)
*Circular adhesive white
plastic plate with stud Ø
25 mm (B part)*



Maschio su base adesiva circolare Ø
40 mm in plastica morbida flessibile
*Stud on circular adhesive base Ø 40
mm in soft and flexible plastic*
320-200 AD 40 Bianco / *White*
320-200 CL 40 Trasparente /
Transparent



Molla su base adesiva circolare Ø 25
mm in plastica morbida flessibile
*Socket on circular adhesive base Ø 25
mm in soft and flexible plastic*
320-100 AD 25 Bianco / *White*
320-100 CL 25 Trasparente /
Transparent



Maschio su base adesiva circolare Ø
25 mm in plastica morbida flessibile
*Stud on circular adhesive base Ø 25
mm in soft and flexible plastic*
320-200 AD 25 Bianco / *White*
320-200 CL 25 Trasparente /
Transparent

FISSAGGI PER TAPPEZZERIA

FIXINGS FOR UPHOLSTERY



560-400

Apparecchio manuale ad aria calda per saldatura PVC
Manual hot air device for PVC welding



560-401

Rullo in gomma ad un braccio - 44 mm
One-arm rubber roller - 44 mm



560-403

Beccuccio mm 20
Spout mm 20

560-404

Beccuccio mm 40
Spout mm 40

Fissaggi per tappezzeria • Fixings for upholstery

FISSAGGI PER TAPPEZZERIA

FIXINGS FOR UPHOLSTERY



370-100
Dispenser progettato per essere utilizzato insieme al nastro biadesivo per facilitarne l'applicazione.
N.B. il dispenser non viene fornito con il nastro incluso

Dispenser designed to be used together with double-sided adhesive tape to facilitate application.

N.B. the dispenser is not supplied with the included tape



370-113
Nastro per termosaldatrice a caldo per sigillare le cuciture (h 2,5cmx50mt)
Colori: blu, beige, bianco e nero
Tape for heat sealer to seal the seams (h 2,5cmx50mt)
Colors: blue, beige, white and black



Biadesivo acrilico in solvente modificato con supporto in tnt e liner bisiliconato verde in polietilene. Non necessita dell'uso delle forbici, si può posizionare e poi strappare semplicemente il nastro.
Double sided solvent acrylic modified with support in tnt and liner bisiliconato green polyethylene. Does not require the use of scissors, you can place and simply tearing the tape.

370-107 Nastro transfer biadesivo in TNT mm 6 x 25 mt
370-108 Nastro transfer biadesivo in TNT mm 9 x 25 mt
370-109 Nastro transfer biadesivo in TNT mm 12 x 25 mt

Biadesivo dall'alto potere di incollaggio. Resistente ai raggi UV ed alle alte temperature. Molto sottile e trasparente, ottimo per incollare spinnaker e laminati anche senza cuciture.
Double-sided adhesive with high bonding power. Resistant to UV rays and high temperatures. Very thin and transparent, excellent for gluing spinnakers and laminates even without seams.

370-104 Nastro transfer biadesivo mm 6 x 50 mt
370-105 Nastro transfer biadesivo mm 9 x 50 mt
370-106 Nastro transfer biadesivo mm 12 x 50 mt

370-110
Nastro biadesivo per tessuti acrilici mm 9 x 50 mt
Double-sided adhesive tape for acrylic fabrics mm 9 x 50 mt

370-111
Nastro biadesivo per tessuti acrilici mm 12 x 50 mt
Double-sided adhesive tape for acrylic fabrics mm 12 x 50 mt



257-000
Nastro di rinforzo in PVC - H 10 cm x 50 mtl
Reinforcement tape in PVC - H 10 cm x 50 mtl



257-001
Nastro di rinforzo in PVC - H 15 cm x 50 mtl
Reinforcement tape in PVC - H 15 cm x 50 mtl

BORDINI TAPES



250-201

Bordino per bordare cappote in acrilico tinto in massa h 20 mm lunghezza rotoli 150 mt. Per la gamma colori vedere il campionario Tempotest Marine/Home.

Acrylic dyed tape for capote borders h 20 mm length rolls 150 meters. For the range of the colours please have a look at the Tempotest Marine/home

Cartella colori / colour book art. 250-201/250-201

PASSAMANERIA PER MANTOVANE / BINDING TAPE

Colori e numerazioni sono identici alle tinte unite del campionario Tempotest / Colours and references are the same as Tempotest range

15	93*	15/1	52	14	1481*	94	929*	926*	57	930
54*	58*	12	73	84*	11	98*	20*	25*	26*	55*
72	56	62*	7	5*	8*	24	81*	97	75	87*
10*	13*	74*	77*	79*	21	71*	16*	6		

*su richiesta,
minimo 6 rotoli

*on demand,
minimum 6 rolls

Bordini • Tapes

BORDINI TAPES

250-300

Bordino in acrilico tinto in massa h25mm per la bordatura delle capotte.

Colori vari

Acrylic dyed tape for capote and cover borders h25mm. Various colours



JB-5548 TAUPE (Rif. Tempotest 926)



JB-5031 MARINE BLUE (Rif. Tempotest 75)



JB-5057 CAPTAIN NAVY (Rif. Tempotest 92)



JB-5049 CHARCOAL GREY (Rif. Tempotest 97)



JB-5032 JET BLACK (Rif. Tempotest 24)



JB-5026 DUNE (Rif. Tempotest 52)



JB-5050 LINEN (Rif. Tempotest 102)



JB-P011 STONE (Rif. Tempotest 15/79)

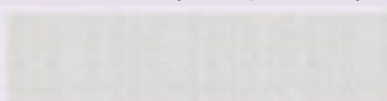

JB-5020 NATURAL (Rif. Tempotest 15)



250-350

Bordino prodotto con lo stesso tessuto

per le capotte ripiegato sui lati h25mm.

Rotoli da 50 mt. Colori vari

Acrylic dyed tape for capote made with the same fabric of them. Folded on the borders h25mm. Rolls of 50 mt. Various colours

JB-04 (Rif. Tempotest 15/1)

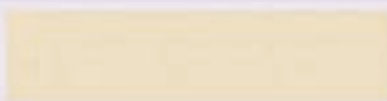

JB-045 (Rif. Tempotest 106)



JB-H044 (Rif. Tempotest 52)



JB-H423 (Rif. Tempotest 926)



JB-H713 (Rif. Tempotest 416)



JB-H055 (Rif. Tempotest 92)



JB-H07 (Rif. Tempotest 94)



JB-H09 (Rif. Tempotest 24)



JB-H011 (Rif. Tempotest 415)



JB-5020 (Rif. Tempotest 15)



BORDINI TAPES

251-001

Nastro in poliestere tinto in massa h25mm. Resistenza ai raggi UVA 7/8.

Rotoli da 100mtl. Riferimento colori TEMPOTEST PARA'

Polyester dyed tape h25mm. UVA resistance 7/8. Rolls 100mt.

Referring to TEMPOTEST PARA' colours

JB-602 BIANCO (Rif. Tempotest 15)



JB-710 CRUDO (Rif. Tempotest 15/1)

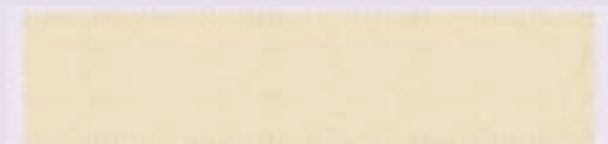

JB-751 BEIGE (Rif. Tempotest 52)



JB-631 GRIS (Rif. Tempotest 94)



JB-127 ROJO (Rif. Tempotest 11)



JB-426 VERDE BOTELLA (Rif. Tempotest 5)



JB-875 AZUL TINTA (Rif. Tempotest 75)

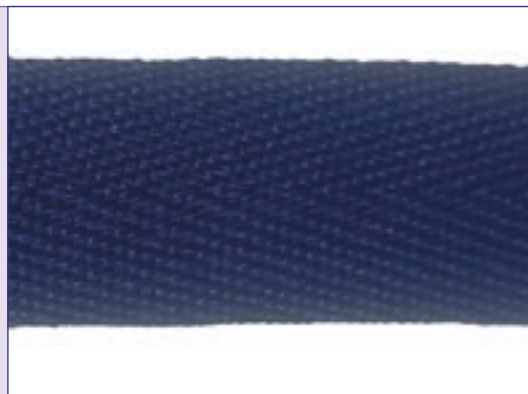

JB-730 AVORIO (Rif. Tempotest 15/52)



JB-230 MARRON (Rif. Tempotest 81)

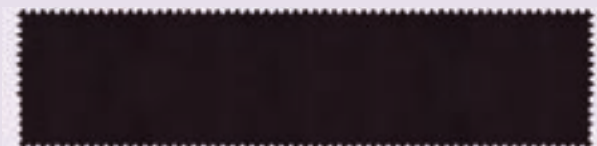

JB-860 AZUL MARINO (Rif. Tempotest 92)



JB-933 BURDEOS (Rif. Tempotest 415)



JB-821 AZUL ROYAL (Rif. Tempotest 416)



JB-501 NEGRO (Rif. Tempotest 24)



Bordini • Tapes

BORDINI TAPES

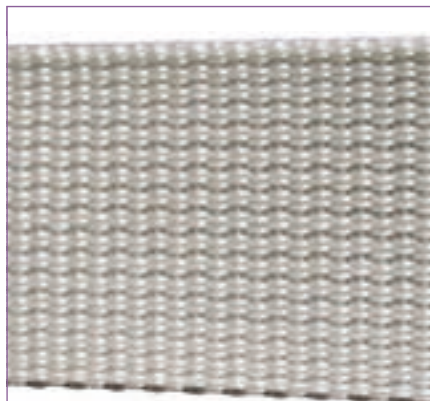

Nastro poliestere pesante tendi capottine
Polyester strong tape for capote

colori / colours: 15 bianco / white, 24 nero / black, 52 beige, 92 blu / navy blue, 79/15 grigio / grey

254-001 h 20 mm
254-002 h 25 mm
254-003 h 30 mm
254-004 h 40 mm
254-005 h 50 mm solo nero e bianco rotolo da 100 mt / black or white only, roll 100 mt

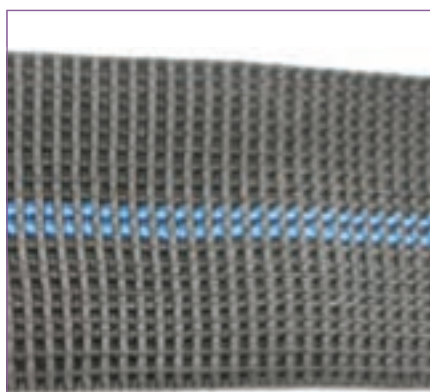

256-000
Cinghia elastica alta 5 cm in rotoli da 100 mt
Elastic band h 5c m roll 100 mt.



Fettuccia poliestere a lisca di pesce.
Col bianco, rotolo 100 mtl
Polyester ribbon for borders. White colour, roll 100 mt
250-001 h 20 mm
250-002 h 25 mm
250-003 h 30 mm



Fettuccia poliestere per bordature.
Colori bianco, nero, blu navy, avorio, rotolo 100 metri.
Polyester tape for borders. Colours white, black, navy blue, ivory, roll 100 mt.
250-101 h 20 mm
250-102 h 25 mm
250-103 h 30 mm



229-025
Cricchetto tendi cinghia per cinghia fino a 25 mm in acciaio inox.
Stainless steel ratchet for belt maximum 25 mm

229-040
Cricchetto tendi cinghia fino a 40 mm in acciaio inox
Stainless steel ratchet for belt maximum 40 mm



256-100
Gancio di fissaggio per cinghia 256-000. Non per uso marino.
Fixing hook for elastic band 256-000. No marine use.



229-042
Fibbia autobloccante per cinghia da 40mm (2pz)
Self-locking buckle for belt 40mm (2pcs)

CORDA ELASTICA

ELASTIC ROPE



Corda elastica con segnale di colore azzurro. Rotoli da 100 metri
Elastic rope with azure sign. Roll 100 meters

- 240-001** Ø 3 mm
- 240-002** Ø 4 mm
- 240-003** Ø 5 mm
- 240-004** Ø 6 mm
- 240-005** Ø 8 mm
- 240-006** Ø 10 mm



Corda elastica nera. Rotoli da 100 metri
Black elastic rope. Roll 100 meters

- 240-103*** Ø 3 mm
- 240-104*** Ø 4 mm
- 240-105*** Ø 5 mm
- 240-106*** Ø 6 mm
- 240-108*** Ø 8 mm

Filo • Yarn

FILO YARN



FILO POLIAMIDE ad alta tenacità. Colori vari
POLYAMIDE YARN high strong quality. Various colours

380-051 titolo 20/3 spola 2000 mtl
count 20/3 spool 2000 meters

380-061 titolo 30/3 spola 2500 mtl
count 30/3 spool 2500 meters

380-081 titolo 40/3 spola 4000 mtl
count 40/3 spool 4000 meters

380-181 titolo 80/3 spola 4000 mtl
count 80/3 spool 4000 meters

		titolo 10	titolo 20	titolo 30	titolo 40	01
Not. White	7003U	•	•			
Crema	7600U	•				
Sunflower Gold	7466U	•	•			
Ochre	7477U					
Orange	7800U		•			
Toboggan	7890U					
Magma	7904U		•			
Red	7905U		•	•		
Burgundy	7997U					
Black Cherry	7983U					
Pacific Blue	8421U		•			
Mediterranean	8403U		•	•		
Royal Blue	8578U		•			
Marine Blue	8555U					
Navy	8566U		•			
Forest Green	8847U		•			
Seagrass Green	8857U		•			

		titolo 10	titolo 20	titolo 30	titolo 40	02
Dark Olive	7567U					
Sand	7680U					
Sandstone	7622U		•			
Olive Brown	7654U					
Beaver	7582U		•	•		
Saddle	7719U					
Nutmeg	7762U		•			
Brown	7765U		•			
Bay Brown	7793U					
Storm Grey	7077U			•		
Cloudy sky	7069U			•		
Pearl Grey	7070U		•			
Shark Grey	7090U		•			
Charcoal	7115U		•	•		
Med. Steel	7113U					
Graphite	7182U					
Black	7020U		•	•		

FILO BONDERIZZATO
specifico per uso nautico
resistente ai raggi UVA
BONDERIZED YARN
specific for nautical use.
UVA resistant

Serabond.10
titolo 10 *count 10*

Serabond.20
titolo 20 *count 20*

Serabond.30
titolo 30 *count 30*

Serabond.40
titolo 40 *count 40*

Serabond 20 e 40 sono disponibili solo nei colori segnati con "•"
Serabond 20 and 40 are available in colours marked with "•"

PRODOTTI VARI PRODUCTS



370-505

Silicone spray per chiusure lampo. Confezione da 400ml
Silicone spray for zippers. 400ml



370-508

Silicone spray Tempotest Para' per ripristinare l'idrorepellenza nei tessuti. Confezione da 400ml.
Silicone spray Tempotest Para' to replace the waterproof repellence of the fabrics. 400ml



245-000

Coltello a caldo elettrico con lama piatta
Hot electric cutter with flat blade



245-0100R

Lama piatta per coltello 245-000
Flat blade for 245-000

Forbici • Stainless

FORBICI STAINLESS



***339-010**

Forbice inox sarto taglio banco dritta.
Lama 23 cm
*Stainless steel scissors, taylor shears
with straight blade 23 cm*



**Forbice cesoia da sarto
Scissors, taylor shears*

339-000 lunga 18 cm / *length 18 cm*
339/001 lunga 21 cm / *length 21 cm*
339-002 lunga 23 cm / *length 23 cm*
339-003 lunga 26 cm / *length 26 cm*



339-100 Forbice inox sartina cm 8,5
con logo magicotex
339-101 Forbice inox sarto cm 10,5
con logo magicotex - antibatteriche
339-102 Forbice inox sarto cm 9,5
con logo magicotex
339-103 Forbice inox sarto cm 10,5
con logo magicotex
339-104 Forbice inox sarto cm 11
con logo magicotex
339-105 Forbice inox sartina cm 8,5
con logo magicotex - per mancini
339-106 Forbice inox sartina cm 8,5
con logo magicotex-antibatteriche

GOMMA PER IMBOTTITURE

FOAM MATTRESSES



POLIETILENE A CELLULA CHIUSA MULTISTRATO POLYETHYLENE FOAM WITH CLOSED CELLS

20/25 kg/cm in lastre da / mattresses 100x200 cm

188-010P spessore / thickness 10 mm

188-020P spessore / thickness 20 mm

188-030P spessore / thickness 30 mm

188-040P spessore / thickness 40 mm

188-050P spessore / thickness 50 mm

188-060P spessore / thickness 60 mm

***188-070P** spessore / thickness 70 mm

188-080P spessore / thickness 80 mm

***188-100P** spessore / thickness 100 mm

30kg/cm lastre da / mattresses 140x200 cm

186-010 spessore / thickness 10 mm

186-020 spessore / thickness 20 mm

186-030 spessore / thickness 30 mm

186-040 spessore / thickness 40 mm

186-050 spessore / thickness 50 mm

POLIETILENE ESPANSO MULTISTRATO/ RETICOLATO TIPO LU-SOFT

Lastre da / mattresses 150x200 cm

186-010LU spessore / thickness 10 mm

186-020LU spessore / thickness 20 mm

186-030LU spessore / thickness 30 mm

186-040LU spessore / thickness 40 mm

186-050LU spessore / thickness 50 mm

186-060LU spessore / thickness 60 mm

186-070LU spessore / thickness 70 mm

186-080LU spessore / thickness 80 mm

186-100LU spessore / thickness 100 mm

POLIETILENE ESPANSO RETICOLATO TIPO N - DENSITA' 30

Lastre da/ mattresses 150x200 cm

183-010 spessore / thickness 10 mm

183-020 spessore / thickness 20 mm

183-030 spessore / thickness 30 mm

183-040 spessore / thickness 40 mm

183-050 spessore / thickness 50 mm

183-060 spessore / thickness 60 mm

183-080 spessore / thickness 80 mm

***183-100** spessore / thickness 100 mm



FILTREN schiuma reticolata drenante.

FILTREN draining soft foam.

Lastre 100x200 cm / Mattresses 100x200 cm

***187-015** spessore / thickness 15 mm

187-020 spessore / thickness 20 mm

187-030 spessore / thickness 30 mm

187-040 spessore / thickness 40 mm

***187-050** spessore / thickness 50 mm

***187-060** spessore / thickness 60 mm

***187-080** spessore / thickness 60 mm

***187-100** spessore / thickness 100 mm

Lastre 150x200 cm / Mattresses 150x200 cm

182-020 spessore / thickness 20 mm

182-030 spessore / thickness 30 mm

182-040 spessore / thickness 40 mm

182-050 spessore / thickness 50 mm



DUOCELL assemblato di polietilene a cellula chiusa e
filtren. Lastre da 100x200 cm

DUOCELL made by filtren and closed cell. Mattresses
100x200 cm

1630-20 polietilene 30 mm + filtren 20 mm

1640-20 polietilene 40 mm + filtren 20 mm

1640-30 polietilene 40 mm + filtren 30 mm

1650-20 polietilene 50 mm + filtren 20 mm

1650-30 polietilene 50 mm + filtren 30 mm

***1660-20** polietilene 60 mm + filtren 20 mm

Altri spessori su richiesta / Other thickness on demand

Insonorizzanti • Sound-proof

INSONORIZZANTI

SOUND-PROOF

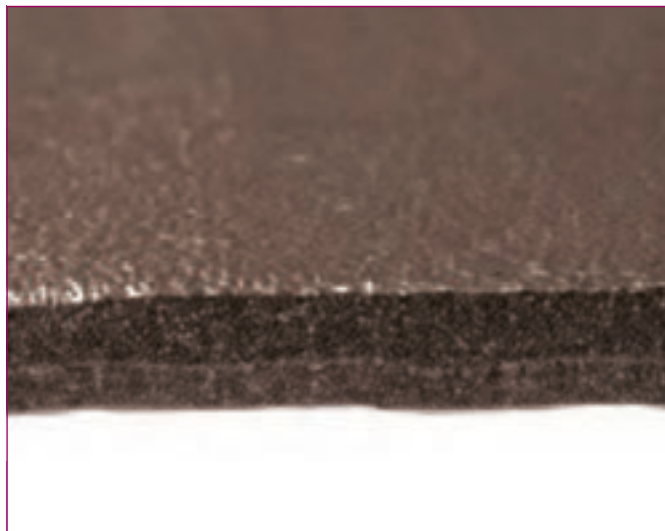

192-000

Poliuretano espanso con lamina piombo all'interno e lamina alluminio all'esterno. Adesivo, spessore 15mm circa, in lastre da 100x100 cm.

Polyurethane foam with lead foil on the inside and aluminium foil on the surface. Adhesive on the back, thickness 15mm. mattresses 100x100 cm.



193-070

Poliuretano espanso piramide in lastre da 100x100 cm spessore 70 mm

Pyramidale surface polyurethane foam in sheet 100x100 cm thickness 70 mm

BINARI PER TENDE

TEND RAILS

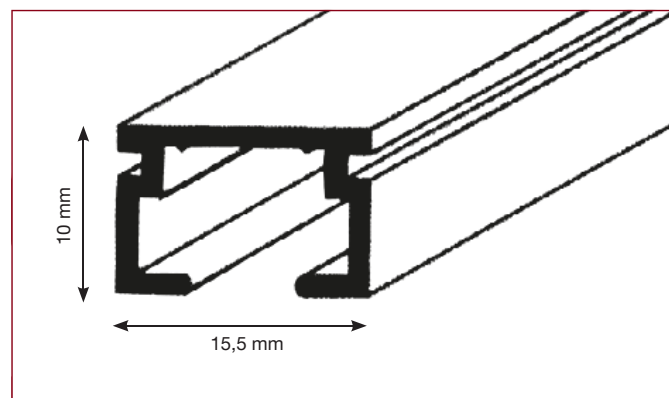

390-2010 A*

Barre in alluminio da 3 mt / *Aluminum bars of 3 meters*

390-2010 VB*

Barre in alluminio verniciate di bianco da 3 mt
White painted aluminum bars of 3 meters

390-2010 B*

Barre in alluminio color bronzo da 3 mt
Bronze painted aluminum bars of 3 meters

390-2010 VN*

Barre in alluminio verniciate di nero da 3 mt
Black painted aluminum bars of 3 meters

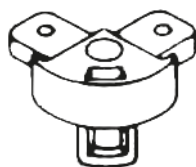

390-AB1036*

Angolare - confezione da 20 pezzi
Angular - pack of 20 pieces



390-AB1014*

Scorrevole in materozza - confezione da 500 pezzi
Sliding for tents - pack of 500 pieces



390-800*

Gancetto a chiocciola grande - confezione da 1000 pezzi
Large hook - pack of 1000 pieces



390-801*

Gancetto a chiocciola piccolo - confezione da 1000 pezzi
Small hook - pack of 1000 pieces



390-AB1015*

Arresto girevole - confezione da 100 pezzi
Rotating stop - pack of 100 pieces



390-F190*

Fermo in nylon - confezione da 100 pezzi
Retainer for tents - pack of 100 pieces



390-AB1037*

Carrucola - confezione da 50 pezzi
Pulley - pack of 50 pieces



390-AB1035*

Supporto a soffitto - confezione da 100 pezzi
Ceiling support - pack of 100 pieces

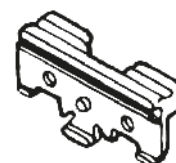

390-AB1038*

Carrello guidato - confezione da 25 pezzi
Cart for tents - pack of 25 pieces

Binari per tende • *Tend rails*

BINARI PER TENDE

TEND RAILS

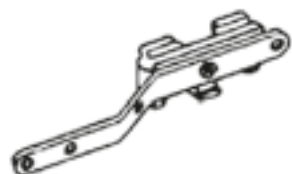

390-AB1050*

Carrello con asta in metallo -
confezione da 25 pezzi
Cart with metal rod - pack of 25 pieces

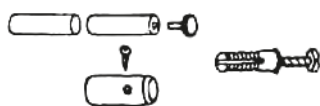

390-E418*

Tirante in alluminio cm 100 con tasselli
e viti - confezione da 6 pezzi
*Aluminum rod 100 cm with plugs and
screws - pack of 6 pieces*

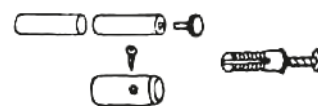

390-E419*

Tirante in alluminio cm 120 con
tasselli e viti - confezione da 6 pezzi
*Aluminum rod 120 cm with plugs and
screws - pack of 6 pieces*



390-1014G*

Scorrevoli a ruote
confezione da 500 pezzi
*Sliding for tends with metal hook
pack of 500 pieces*



390-AB1074*

Gancio in inox
confezione da 500 pezzi
*Inox hook
pack of 500 pieces*



390-AB802*

Gancio con aletta a cucire
confezione da 250 pezzi
*Hook with flap to sew
pack of 250 pieces*



390-AB1102*

Vite con dado
confezione da 100 pezzi
*Intermediate metal stop
pack of 100 pieces*



390-C664*

Cordocino alta tenacità Ø 2 mm
confezione da 500 mt
*High tenacity cord Ø 2 mm
500 mt package*



390-C641*

Fiocco tendi corda
gr. 40 - confezione
da 20 pezzi
*Tensioner gr. 40 -
pack of 20 pieces*



390-C642*

Fiocco tendi corda gr. 70
confezione da 20 pezzi
*Tensioner gr. 70
pack of 20 pieces*



Mensola in acciaio
confezione da 25 pezzi
*Steel shelf
pack of 20 pieces*

390-AB1051* mm 40
390-AB1052* mm 60
390-AB1053* mm 100
390-AB1054* mm 150

BINARI PER TENDE

TEND RAILS

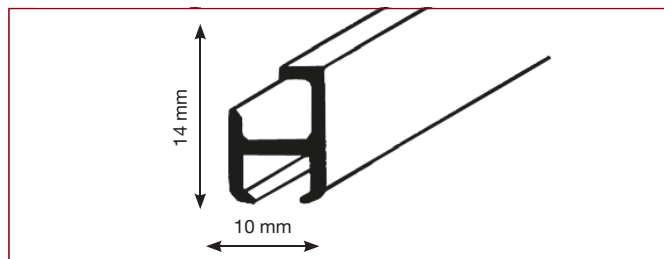

390-2011A*

Barre in alluminio da 3 mt / *Aluminum bars of 3 meters*

390-2011 VB*

Barre in alluminio verniciate di bianco da 3 mt / *White painted aluminum bars of 3 meters*



390-E191*

Coppia di terminali per binario a strappo - confezione da 25 coppie

Pair of terminals for hook-and-loop track - pack of 25 pairs

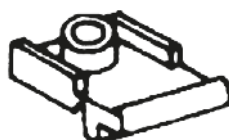

390-E140*

Supporto a soffitto - confezione da 100 pezzi

Ceiling support - 100 pieces pack

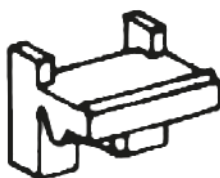

390-E141*

Supporto a parete - confezione da 100 pezzi

Wall support - 100 pieces pack



390-E142*

Supporto a soffitto per doppio binario - confezione da 100 pezzi

Ceiling mount for double track - 100 pieces package



390-1042*

Arresto girevole per canale stretto - confezione da 100 pezzi

Swivel stop for narrow channel - 100 pieces pack



390-1019*

Scorrevole in materozza per canale stretto - confezione da 1000 pezzi

Sliding for narrow channel - 1000 pieces pack



390-AB1046*

Vite con dado - confezione da 100 pezzi

Intermediate metal stop - pack of 100 pieces



390-800*

Gancetto a chiocciola grande - confezione da 1000 pezzi

Large hook - pack of 1000 pieces



390-801*

Gancetto a chiocciola piccolo - confezione da 1000 pezzi

Small hook - pack of 1000 pieces

Binari per tende • *Tend rails*

BINARI PER TENDE

TEND RAILS

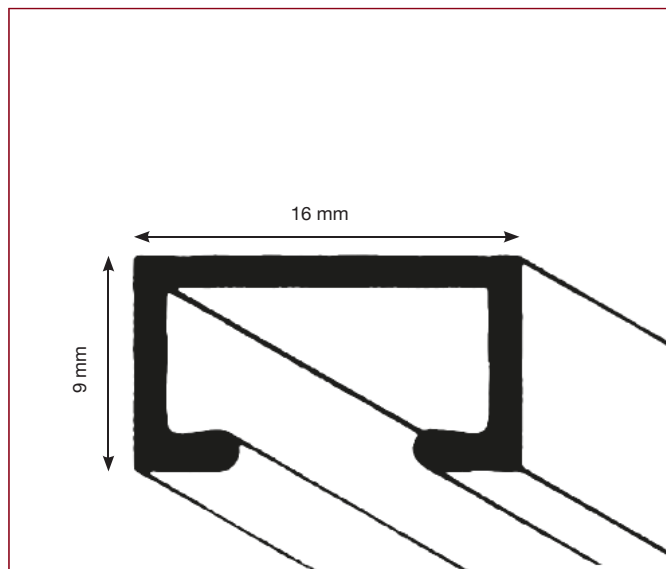

390-F101*

Profilo a U in PVC bianco - barre da 2,5 mt
U-shaped profile in white PVC - 2.5 meters bars



390-AB1014*

Scorrevole in materozza - confezione da 500 pezzi
Sliding for tents - pack of 500 pieces

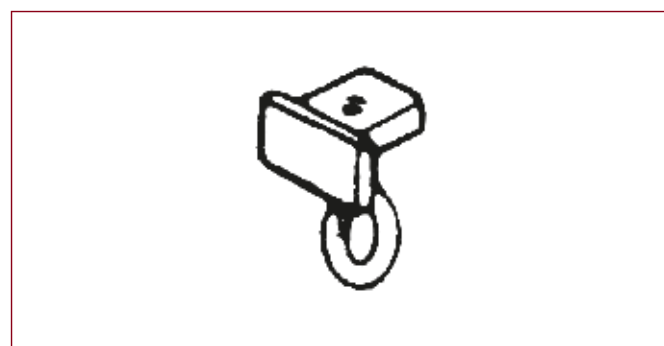

390-F190*

Fermo in nylon - confezione da 100 pezzi
Retainer for tents - pack of 100 pieces



390-800*

Gancetto a chiocciola grande - confezione da 1000 pezzi
Large hook - pack of 1000 pieces



390-801*

Gancetto a chiocciola piccolo - confezione da 1000 pezzi
Small hook - pack of 1000 pieces

BINARI PER TENDE

TEND RAILS

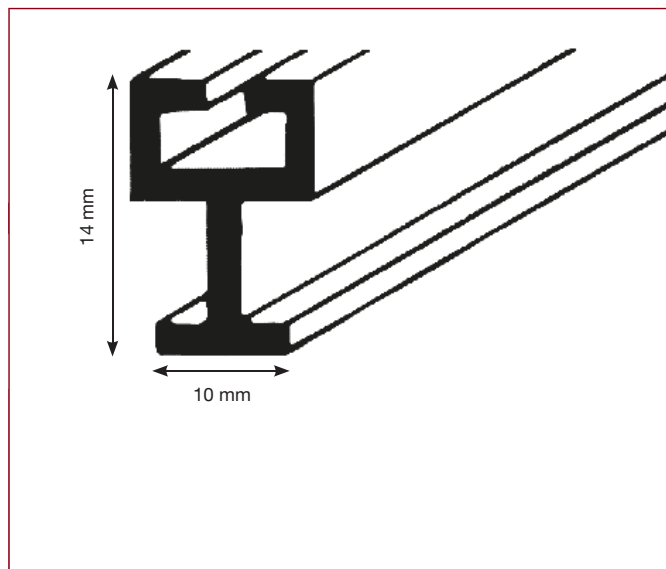

390-N101*

Profilo a U in PVC bianco - barre da 2,5 mt
U-shaped profile in white PVC - 2.5 meters bars



390-N190

Fermo - confezione da 100 pezzi
Fastener - 100 pieces pack

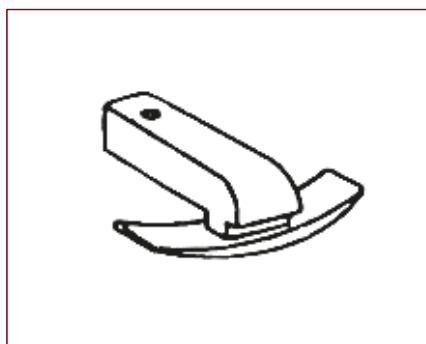

390-N120*

Supporto soffitto - confezione da 100 pezzi
Ceiling support - pack of 100 pieces

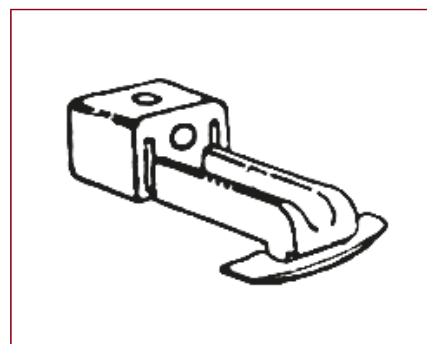

390-N110*

Supporto parete/soffitto - confezione da 100 pezzi
Wall / ceiling support - 100 pieces pack



390-800*

Gancetto a chiocciola grande - confezione da 1000 pezzi
Large hook - pack of 1000 pieces



390-801*

Gancetto a chiocciola piccolo - confezione da 1000 pezzi
Small hook - pack of 1000 pieces

Binari per tende • *Tend rails*

BINARI PER TENDE

TEND RAILS



390-C802*

Fettuccia monobava a corde arricciatura continua mm 70, rapporto max 1:4 - confezione da 50 mt



390-C803*

Fettuccia con corde arricciatura tasche ogni 3 cm - mm 65 - rapporto max 1:3 - confezione da 50 mt



390-C804*

Fettuccia multi tasche mm80 - confezione da 50 mt



390-C805*

Fettuccia con due corde, arricciatura continua mm 30 - confezione da 100 mt



390-C814*

Nastro termo adesivo per tenda a pacchetto - confezione da 100 mt



390-C815*

Nastro con anelli in plastica cuciti per tenda a pacchetto - confezione da 100 mt



390-C817*

Nastro per tenda a pacchetto con tasche oer anelli da inserire - confezione da 100 mt

NOTE NOTES



Note • Notes

NOTE NOTES



A series of horizontal dotted lines for writing notes, spanning the width of the page below the header.

NOTE NOTES



Note • Notes

NOTE

NOTES



A series of horizontal dotted lines spanning the width of the page, intended for writing notes.

NOTE NOTES





Agenti • Agents

AGENTI

AGENTS

La presenza di MAGICOTEX dislocata su tutto il territorio italiano e in diversi paesi europei è garantita dall'ampia rete di agenti che gestiscono professionalmente i rapporti con i nostri clienti. Si ricorda che la vendita è riservata esclusivamente al B2B (è necessario essere in possesso di una P.Iva). Non è possibile effettuare vendite ai privati.

RESPONSABILE RETE COMMERCIALE

MAURIZIO BARTOLI • 331 2268153 • info@magicotex.com

ABRUZZO E MOLISE

ANGELOZZI ENNIO • 335 6674328 • ennio.angelozzi@gmail.com

CALABRIA

VENTURA MAURIZIO • 329 8041720 • agenziaventura@alice.it

CAMPANIA

FLAMINIO MAURIZIO • 329 2214802 • maurizioflaminio6@gmail.com

EMILIA ROMAGNA

BARTOLI MAURIZIO • Zone: eccetto Piacenza • 331 2268153 • maurziobartoli2@gmail.com

LIGURIA

CECCARELLI MARCO • Zone: La Spezia e Provincia • 349 6174372 • marcoceccarelli4@gmail.com

BARTOLI MAURIZIO • Zone: eccetto La Spezia e Provincia • 331 2268153 • maurziobartoli2@gmail.com

LOMBARDIA E PIACENZA

GERVASI SILVIA • 328 6414916 • silvia@silviagervasi.com

MARCHE

BARTOLI MAURIZIO (NAUTICA) • 331 2268153 • maurziobartoli2@gmail.com

PASQUINI MAURO (ARREDAMENTO) • 335 5729798 • mauro2255@yahoo.it

PUGLIA E BASILICATA

HAZAN GIOSAFATTE • 347 9438470 • hazangiosi@yahoo.it

SARDEGNA

GF SOLUTIONS • 392 5166352 • effesepe@gmail.com

SICILIA

BONANNO LIBORIO MASSIMO • 328/8877120 • bonannolm74@gmail.com

TOSCANA

CECCARELLI MARCO • Zone: Province di Livorno, Lucca, Massa Carrara, Pisa • 349 6174372 • marcoceccarelli4@gmail.com

PASQUINI MAURO • Zone: Province di Arezzo, Firenze, Grosseto, Pistoia, Prato, Siena • 335/5729798 • mauro2255@yahoo.it

TRIVENETO

LEONARDO TONIOLO • 366/4280545 • toniolo.leonardo@gmail.com

UMBRIA E LAZIO

ANGELUCCI PIERPAOLO • 340/8539865 • pierpaolo.angelucci@alice.it



Magicotex SRL

Via Maestri del Lavoro, 200 / D
40024 Castel S. Pietro Terme (Bo)
Tel. +39 051 941253 > Fax +39 051 941283
info@magicotex.com > www.magicotex.com